

# JVC



ENGLISH

DEUTSCH

FRANÇAIS

NEDERLANDS

## CD RECEIVER

CD-RECEIVER

RECEPTEUR CD

CD-RECEIVER

# KD-SH9104/KD-SH9103/ KD-SH9102/KD-SH9101

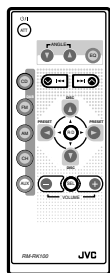
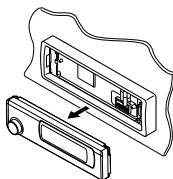

WMA  
MP3

BBE  
DIGITAL

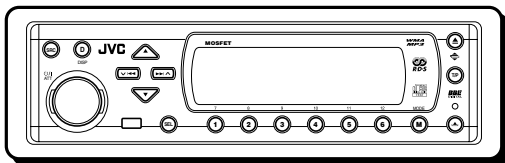

This unit is equipped with the display demonstration. To cancel it, see page 8.

Dieses Gerät ist mit einer Demonstrationsfunktion für das Display ausgestattet. Auf

Seite 8 wird beschrieben, wie Sie diese Demonstrationsfunktion deaktivieren können.

Cet appareil est équipé d'une démonstration des affichages. Pour l'annuler, référez-vous à la page 8.

Dit toestel heeft een display-demonstratiefunctie. Zie bladzijde 8 voor het annuleren van deze functie.

For installation and connections, refer to the separate manual.

Angaben zu Einbau und Verkabelung entnehmen Sie bitte der gesonderten Anleitung.

Pour l'installation et les raccordements, se référer au manuel séparé.

Zie de afzonderlijke handleiding voor details aangaande het installeren en verbinden van het toestel.

## INSTRUCTIONS

BEDIENUNGSANLEITUNG  
MANUEL D'INSTRUCTIONS  
GEBRUIKSAANWIJZING

LVT1005-001B  
[E/EX]

## Position And Reproduction Of Labels

Bottom panel of the main unit

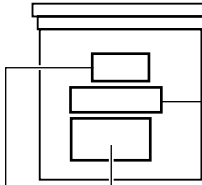

Name/Rating plate

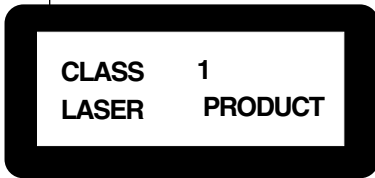

**Caution:**

This product contains a laser component of higher laser class than Class 1.

<b>CAUTION:</b> Invisible laser radiation when open and interlock failed or defeated. <b>AVOID DIRECT EXPOSURE TO BEAM.</b>	<b>ADVARSEL:</b> Usynlig laserstråling ved åbning, når sikkerhedsafbrydere er ude af funktion. Undgåudsættelse for stråling. (e)	<b>VARNING:</b> Osynlig laserstråling når denna del är öppnad och spärren är urkopplad. Betrakta ej strålen. (d)	<b>VARO:</b> Avattaessa ja suojalukitus ohitettaessa olet alltiina näkymättömälle lasersäteilylle. <b>Älä katso säteeseen.</b> (f)
---	--	--	--

### IMPORTANT FOR LASER PRODUCTS

**Precautions:**

1. CLASS 1 LASER PRODUCT
2. **CAUTION:** Invisible laser radiation when open and interlock failed or defeated. Avoid direct exposure to beam.
3. **CAUTION:** Do not open the top cover. There are no user-serviceable parts inside. Leave all servicing to qualified service personnel.
4. **CAUTION:** This CD player uses invisible laser radiation and is equipped with safety switches to prevent radiation emission when unloading CDs. It is dangerous to defeat the safety switches.
5. **CAUTION:** Use of controls, adjustments or performance of procedures other than those specified herein may result in hazardous radiation exposure.

**Note:**

For security reasons, a numbered ID card is provided with this unit, and the same ID number is imprinted on the unit's chassis. Keep the card in a safe place, as it will help the authorities to identify your unit if stolen.

### How to reset your unit

Press the reset button on the control panel using a ball-point pen or similar tool. This will reset the built-in microcomputer.

**Note:**

Your preset adjustments—such as preset channels or sound adjustments—will also be erased.

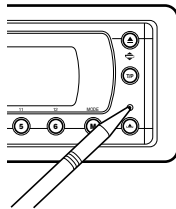

**CAUTION:**

NEVER insert your finger in between the control panel and the unit, as it may get caught or hurt. (See page 52.)

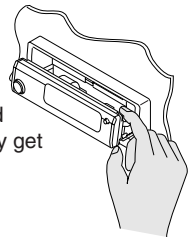

### BEFORE USE

**\*For safety....**

- Do not raise the volume level too much, as this will block outside sounds, making driving dangerous.
- Stop the car before performing any complicated operations.

**\*Temperature inside the car....**

If you have parked the car for a long time in hot or cold weather, wait until the temperature in the car becomes normal before operating the unit.

Thank you for purchasing a JVC product. Please read all instructions carefully before operation, to ensure your complete understanding and to obtain the best possible performance from the unit.

# CONTENTS

How to reset your unit .....	2	<b>SOUND ADJUSTMENTS</b> .....	<b>37</b>
<b>LOCATION OF THE BUTTONS</b> .....	<b>4</b>	Performing the basic sound settings .....	37
Control panel .....	4	<b>GRAPHIC DISPLAYS</b> .....	<b>39</b>
Remote controller .....	5	Downloading images and animations .....	40
Preparing the remote controller .....	6	Deleting unwanted files .....	42
<b>BASIC OPERATIONS</b> .....	<b>7</b>	Activating the downloaded images and animations .....	44
Turning on the power .....	7	<b>OTHER MAIN FUNCTIONS</b> .....	<b>46</b>
Canceling the display demonstration .....	8	Changing the general settings (PSM) .....	46
Setting the clock .....	8	Selecting the dimmer mode .....	50
Selecting the level meter .....	9	Assigning names to the sources .....	51
<b>RADIO OPERATIONS</b> .....	<b>10</b>	Changing the control panel angle .....	52
Listening to the radio .....	10	Detaching the control panel .....	53
Storing stations in memory .....	12	<b>CD CHANGER OPERATIONS</b> .....	<b>54</b>
Tuning in to a preset station .....	13	Playing discs .....	54
Changing the display pattern .....	14	Locating a folder on a disc .....	57
<b>RDS OPERATIONS</b> .....	<b>15</b>	Selecting a disc/folder/track using the name lists .....	58
What you can do with RDS .....	15	Selecting playback modes .....	59
Other convenient RDS functions and adjustments .....	20	<b>EXTERNAL COMPONENT OPERATIONS</b> ....	<b>61</b>
<b>CD OPERATIONS</b> .....	<b>22</b>	Playing an external component .....	61
About MP3 and WMA discs .....	22	<b>DAB TUNER OPERATIONS</b> .....	<b>62</b>
Playing a disc .....	22	Tuning in to an ensemble and one of the services .....	62
Locating a particular portion on a track .....	24	Storing DAB services in memory .....	64
Locating a track on a disc .....	25	Tuning in to a preset DAB service .....	64
Locating a folder on a disc .....	26	What you can do more with DAB .....	66
Selecting a folder and a track using the name lists .....	28	Changing the display pattern .....	70
Selecting playback modes .....	29	<b>ADDITIONAL INFORMATION</b> .....	<b>71</b>
Prohibiting disc ejection .....	30	<b>TROUBLESHOOTING</b> .....	<b>72</b>
Changing the display pattern .....	31	<b>MAINTENANCE</b> .....	<b>74</b>
<b>DSP OPERATIONS</b> .....	<b>32</b>	Handling discs .....	74
Selecting the DSP modes .....	32	<b>SPECIFICATIONS</b> .....	<b>75</b>
<b>EQUALIZER OPERATIONS</b> .....	<b>35</b>		
Selecting preset sound modes (iEQ: intelligent equalizer) .....	35		
Storing your own sound modes .....	36		

**CAUTION on Volume Setting:**

Discs produce very little noise compared with other sources. If the volume level is adjusted for the tuner, for example, the speakers may be damaged by the sudden increase in the output level. Therefore, lower the volume before playing a disc and adjust it as required during playback.

**Caution:**

If the temperature inside the car is below 0°C, the movement of animation and text scroll will be halted on the display to prevent the display from being blurred.  (LOW TEMP.) indicator appears on the display.

When the temperature increases, and the operating temperature is resumed, these functions will start working again.



# LOCATION OF THE BUTTONS

ENGLISH

## Control panel

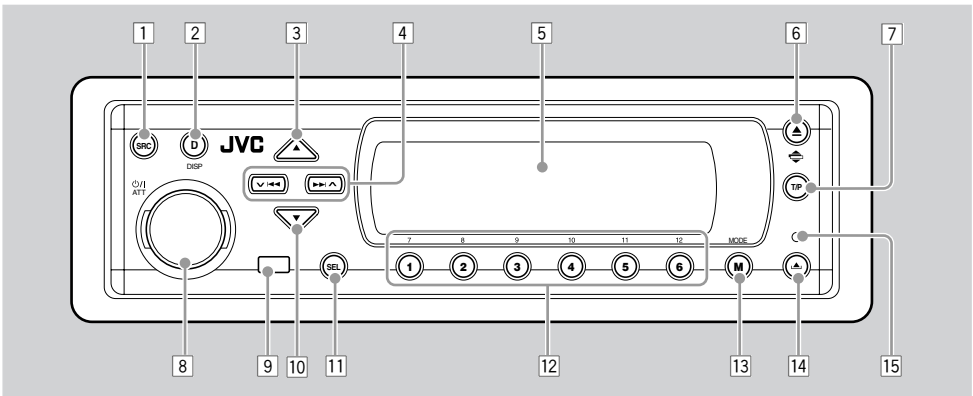

- 1 SRC (source) button
- 2 DISP (D) (display) button
- 3 ▲ (up) button
- 4 ▼ ◀▶▶▶ ▲ buttons
- 5 Display window
- 6 • ▲ (eject) button  
• ◀▶ (angle) button
- 7 T/P (traffic programme/programme type) button
- 8 • ⏻/ATT (standby/on/attenuator) button  
• Control dial
- 9 Remote sensor
- 10 ▼ (down) button
- 11 SEL (select) button
- 12 Number buttons
- 13 MODE (M) button
- 14 ◀▶ (control panel release) button
- 15 Reset button

### Illumination Navigation for easy operations:

If you use MODE (M) or SEL (select), the display and some controls (such as the number buttons, ▼ ◀▶▶▶ ▲, ▲ / ▼, and control dial) enter the corresponding control mode, then the controls start flashing to lead you to the next operational steps. (Illumination Navigation)

- The display show how these buttons function during this period.

Ex. When you press number button 1 after pressing MODE (M), to operate the FM tuner.

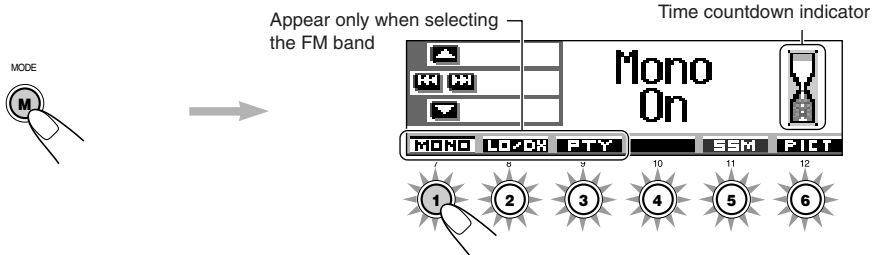

**To use these controls for original functions again,** wait until the controls stop flashing without using these controls.

- Pressing MODE (M) again also restores original functions. However, pressing SEL (select) makes the unit into a different mode.



# Remote controller

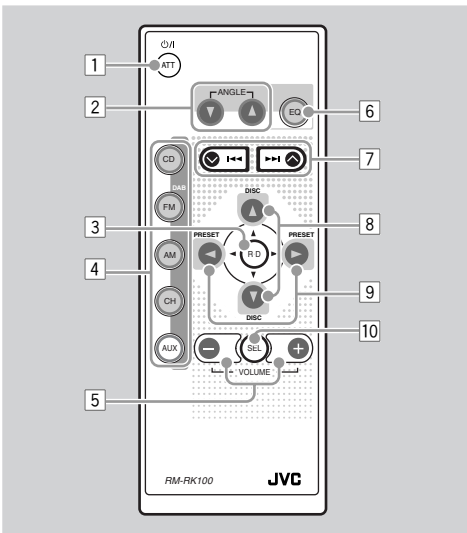

- 1 • Turns on the unit if pressed when the unit is turned off.
- Turns off the unit if pressed and held for a few seconds.
- Drops the volume level in a moment if pressed briefly.  
Press again to resume the volume.
- 2 Changes the angle of the control panel to four positions.
- 3 Skips to the root while listening to an MP3 disc.
- 4 • CD: Selects CD player.
- FM/DAB:
  - Selects FM tuner if pressed briefly. Each time you press the button, FM band (FM1, FM2 and FM3) changes.
  - Selects DAB tuner if pressed and held.\*1 Each time you press and hold the button, DAB band (DAB1, DAB2 and DAB3) changes.
- AM: Selects AM tuner.
- CH: Selects CD changer.\*1
- AUX: Selects the external component (LINE IN).\*2
- 5\*3 • Changes the volume.
- 6 Selects the sound (iEQ) mode. Each time you press the button, the sound (iEQ) mode changes.

- 7 • Searches stations while listening to the radio.
- Selects ensembles while listening to the DAB tuner.
- Fast-forwards or reverses the track if pressed and held while listening to a disc.
- Skips to the beginning of the next track or goes back to the beginning of the current (or previous) tracks if pressed briefly while listening to a disc.
- 8 • Selects services while listening to the DAB tuner.
- Changes the disc number while listening to the CD changer. Each time you press and hold the button, the disc number changes, and the selected disc starts playing.
- Skips to the first track of a folder on a higher hierarchy level or on a lower hierarchy level if pressed briefly while listening to an MP3 or a WMA disc. (This does not function for WMA discs on the MP3-compatible CD changer).
- Adjusts the fader level on the fader/balance adjustment screen.
- 9 • Changes the preset channel number while listening to the radio (or the DAB tuner). Each time you press the button, the preset channel number changes, and the selected station (or service) is tuned in.
- Skips to the first track of the next folder or the first track of the previous folder if pressed and held while listening to an MP3 or a WMA disc.
- Skips to the first track of the next folder or the first track of the previous folder on the same hierarchy level if pressed briefly while listening to an MP3 or a WMA disc. (This does not function for WMA discs on the MP3-compatible CD changer).
- Adjusts the balance level on the fader/balance adjustment screen.
- 10\*3 Turns on or off the fader/balance adjustment screen. Then you can adjust them using the buttons explained above (8) and (9).

\*1 Without connecting the DAB tuner or CD changer, you cannot select it as the source to play.

\*2 If the "Line In" setting is changed to "Off," you cannot select "LINE IN" (see pages 48 and 49).

\*3 These buttons do not function in the preferred setting mode (PSM) adjustment.

## Preparing the remote controller

Before using the remote controller:

- Aim the remote controller directly at the remote sensor on the main unit. Make sure there is no obstacle in between.

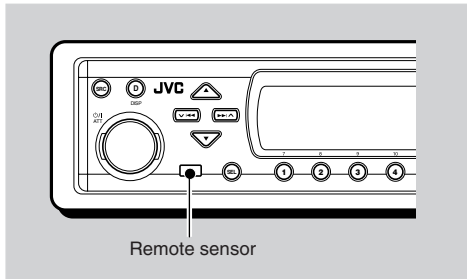

- Do not expose the remote sensor to strong light (direct sunlight or artificial lighting).

### Installing the battery

When the controllable range or effectiveness of the remote controller decreases, replace the battery.

#### 1. Remove the battery holder.

- 1) Push out the battery holder in the direction indicated by the arrow using a ball-point pen or a similar tool.
- 2) Remove the battery holder.

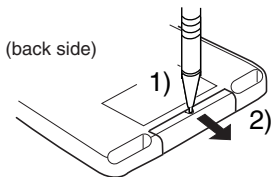

#### 2. Place the battery.

Slide the battery into the holder with the + side facing upwards so that the battery is fixed in the holder.

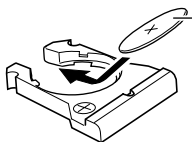

Lithium coin battery  
(product number:  
CR2025)

#### 3. Return the battery holder.

Insert again the battery holder pushing it until you hear a clicking sound.

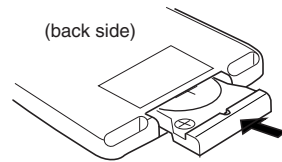

#### WARNING:

- Store the battery in a place where children cannot reach.  
*If a child accidentally swallows the battery, consult a doctor immediately.*
- Do not recharge, short, disassemble or heat the battery or dispose of it in a fire.  
*Doing any of these things may cause the battery to give off heat, crack or start a fire.*
- Do not leave the battery with other metallic materials.  
*Doing this may cause the battery to give off heat, crack or start a fire.*
- When throwing away or saving the battery, wrap it in tape and insulate; otherwise, the battery may start to give off heat, crack or start a fire.
- Do not poke the battery with tweezers or similar tools.  
*Doing this may cause the battery to give off heat, crack or start a fire.*

#### CAUTION:

*DO NOT* leave the remote controller in a place (such as dashboards) exposed to direct sunlight for a long time. Otherwise, it may be damaged.

This receiver is equipped with the steering wheel remote control function. If your car is equipped with the steering wheel remote controller, you can operate this receiver using the controller.

- See the Installation/Connection Manual (separate volume) for connection to utilize this function.

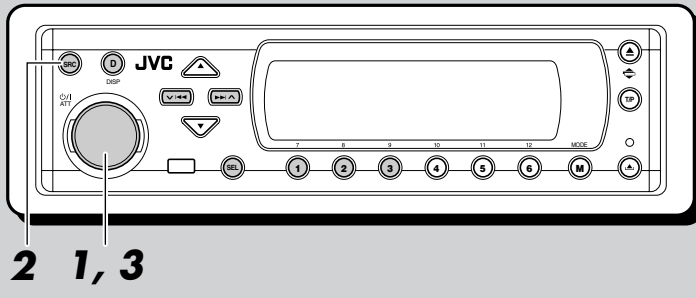

### Display indication:

If you have changed some PSM items (see pages 47 and 48), the indications on the display you see may be different from those used in this manual.

## Turning on the power

### 1 Turn on the power.



#### Note on One-Touch Operation:

When you select a source in step 2 below, the power automatically comes on. You do not have to press this button to turn on the power.

### 2 Select the source.



Each time you press the button, the source changes as follows.

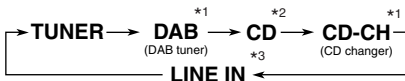

\*1 Without connecting the DAB tuner or CD changer, you cannot select it as the source to play.

\*2 If a disc is not in the loading slot, you cannot select CD as the source to play.

\*3 When "Line In" is set to "Off" in the PSM setting, you cannot select "LINE IN" as the source (see page 49).

### 3 Adjust the volume.

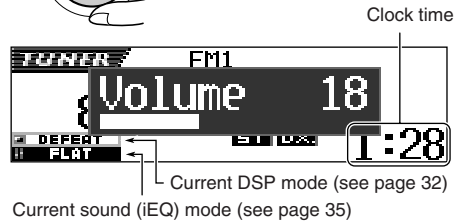
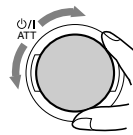

### 4 Select the DSP mode and sound mode as you want.

#### To drop the volume in a moment

Press **ATT** briefly while listening to any source. "ATT" starts flashing on the display, and the volume level will drop in a moment.

To resume the previous volume level, press the button briefly again.

- If you turn the control dial, you can also restore the sound.

#### To turn off the power

Press **ATT** for more than 1 second.

- If you turn off the power while listening to a disc, playback will start from where playback has been stopped previously, next time you turn on the power.

## Canceling the display demonstration

When shipped from the factory, display demonstration has been activated, and starts automatically when no operations are done for about 20 seconds.

- It is recommended to cancel the demonstration before you use the unit for the first time.

To cancel the display demonstration, follow the procedure below:

- Press and hold SEL (select) for more than 2 seconds so that one of the PSM items appears on the display. (PSM: see pages 47 and 48.)



- Press number button 1 to select “MOVIE”—Movie category of the PSM settings.

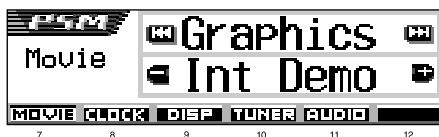

The “Graphics” setting screen appears on the display.

- Select “Off.”

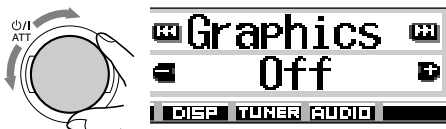

- Finish the setting.



To activate the display demonstration, repeat the same procedure and select “Int Demo” or “All Demo” in step 3.

- For more details, see “To show the graphics on the display—Graphics” on page 48.

## Setting the clock

You can also set the clock system to 24 hours or 12 hours.

- Press and hold SEL (select) for more than 2 seconds so that one of the PSM items appears on the display. (PSM: see pages 47 and 48.)



- Press number button 2 to select “CLOCK”—Clock category of the PSM settings.



The “Clock Hr” setting screen appears on the display.

- Adjust the hour.

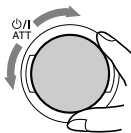

- Set the minute.

- Select “Clock Min (minute).”
- Adjust the minute.

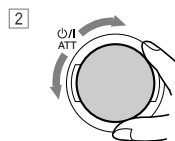
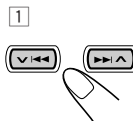





### 5 Set the clock system.

- 1 Select "24H/12H."
- 2 Adjust "24Hours" or "12Hours."



### 4 Select the level meter pattern you want.

As you turn the control dial, the level meters change as follows:

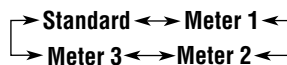

### 6 Finish the setting.



### 5 Finish the setting.



To check the current clock time when the unit is turned off, press DISP (D).

The power turns on and the clock time is shown for about 5 seconds, then the power turns off.

### Standard:

No level meter appears on the display. (Initially selected when shipped from the factory.)

## Selecting the level meter

You can show the level meters on the display while playing any source. This unit is equipped with three level meter patterns.

- 1 Press and hold SEL (select) for more than 2 seconds so that one of the PSM items appears on the display. (PSM: see pages 47 and 48.)



- 2 Press number button 3 to select "DISP"—Display category of the PSM settings.

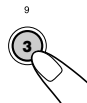

- 3 Select "Theme."

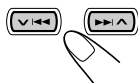

### Meter 1:

The left and right audio level meters appear.

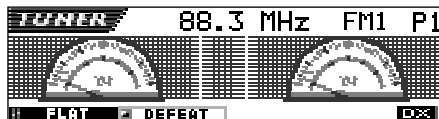

### Meter 2:

Level meters fluctuate horizontally from center to both sides as audio levels changes.



### Meter 3:

Signal waves fluctuate at the center and spread outward.

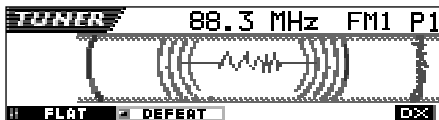

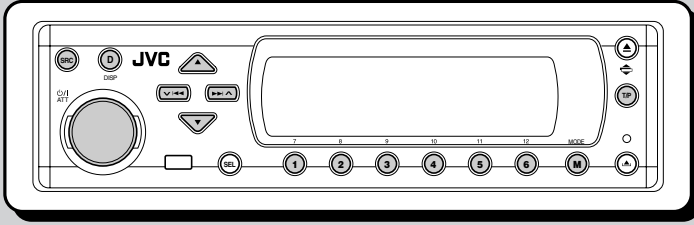

## Listening to the radio

You can use either automatic searching or manual searching to tune in to a particular station.

### Searching a station automatically: Auto search

#### 1 Select the band (FM1 – 3, AM).



- Press SRC (source) repeatedly to select the tuner.
- Press and hold SRC for more than 1 second. The band indication on the display starts flashing.



- Within about 5 seconds (while the band indication is flashing), press SRC again. Each time you press the button, the band changes.

Last received station of the selected band is tuned in.

Program station (PS)  
name (see page 14)

Programme type (PTY)  
(see page 14)

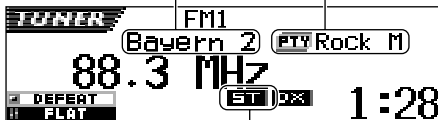

Lights up when receiving an FM stereo broadcast with sufficient signal strength.

#### Note:

This receiver has three FM bands (FM1, FM2, FM3). You can use any one of them to listen to an FM broadcast.

#### 2 Start searching a station.

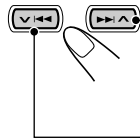

Press **▶▶ ▲** to search stations of higher frequencies.



Press **▼ ◀◀** to search stations of lower frequencies.



Ex. When the band is FM

When a station is received, searching stops.

**To stop searching before a station is received,** press the same button you have pressed for searching.

## To tune in FM stations only with strong signals—LO/DX (Local/Distant)

While searching FM stations (including SSM—see page 12), this unit stops searching whenever it detects signals (DX mode: The DX indicator is lit—initial setting). If received signals are weak, you may only hear noises.

By setting LO/DX to “Local,” you can make this unit detects only stations with sufficient signal strength.

- 1 Press MODE (M) while listening to an FM stereo broadcast. “Mode” appears on the display, and the number buttons start flashing.

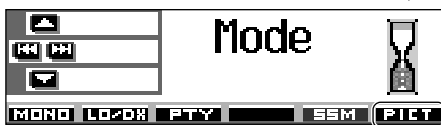
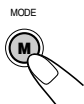

See page 40 for this function.

- 2 Press number button 2, while “Mode” is still on the display. Each time you press the button, the “LO/DX” setting alternates between “Local” and “DX.”

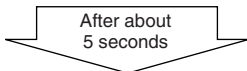

The display returns to the source indication screen.

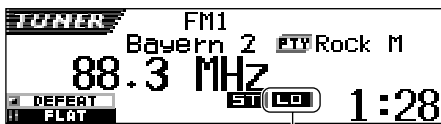

LO indicator appears

## Searching a station manually: Manual search

- 1 Select the band (FM1 – 3, AM).



- 1 Press SRC (source) repeatedly to select the tuner.
- 2 Press and hold SRC for more than 1 second.
- 3 Within about 5 seconds, press SRC again. Each time you press the button, the band changes.

### Note:

This receiver has three FM bands (FM1, FM2, FM3). You can use any one of them to listen to an FM broadcast.

- 2 Press and hold or until “Manual Search” appears on the display.



- 3 Tune in to a station you want while “Manual Search” is still on the display.

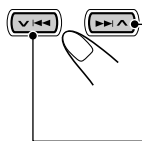

Press to tune in to stations of higher frequencies.



Press to tune in to stations of lower frequencies.

- If you release your finger from the button, the manual mode will automatically turn off after about 5 seconds.
- If you hold down the button, the frequency keeps changing (in 50 kHz intervals for FM and 9 kHz intervals for AM—MW/LW) until you release the button.



## When an FM stereo broadcast is hard to receive:

Set the FM reception mode to “Mono On.”

- 1 Press MODE (M) while listening to an FM stereo broadcast. “Mode” appears on the display, and the number buttons start flashing.



- 2 Press number button 1, while “Mode” is still on the display. Each time you press the button, “Mono On” and “Mono Off” alternately appears.

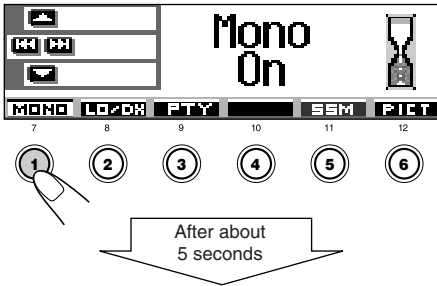

The display returns to the source indication screen.

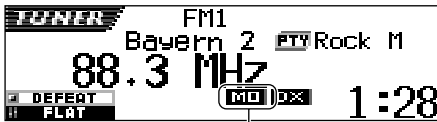

MO indicator appears

### If the sound quality decreases and the stereo effect is lost while listening to an FM station

In some areas, adjacent stations may interfere with each other. If this interference occurs, this unit can automatically reduce this interference noise (initial factory setting). However, in this case, the sound quality will be degraded and the stereo effect will be also lost.

If you do not want to degrade the sound quality and to lose the stereo effect, rather than to eliminate the interference noise, see “To change the FM tuner selectivity—IF Filter” on page 49.

## Storing stations in memory

You can use one of the following two methods to store broadcasting stations in memory.

- Automatic preset of FM stations: SSM (Strong-station Sequential Memory)
- Manual preset of both FM and AM stations

### FM station automatic preset: SSM

You can preset 6 local FM stations in each FM band (FM1, FM2 and FM3).

#### 1 Select the FM band (FM1 – 3) you want to store FM stations into.



- 1 Press SRC (source) repeatedly to select the tuner.

- 2 Press and hold SRC for more than 1 second. The band indication on the display starts flashing.

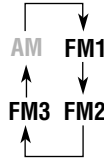

- 3 Within about 5 seconds (while the band indication is flashing), press SRC again. Each time you press the button, the band changes.

#### 2 Start SSM.



- 1 Press MODE (M). “Mode” appears on the display, and the number buttons start flashing.



- 2 Press and hold number button 5 until “- SSM -” appears.

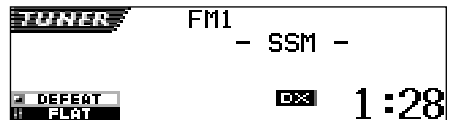

Local FM stations with the strongest signals are searched and stored automatically in the band number you have selected (FM1, FM2 or FM3). These stations are preset in the number buttons — No.1 (lowest frequency) to No.6 (highest frequency).

When automatic preset is over, the station stored in number button 1 will be automatically tuned in.

## Manual preset

You can preset up to 6 stations in each band (FM1, FM2, FM3 and AM) manually.

Ex.: Storing an FM station of 92.5 MHz into the preset number 1 of the FM1 band.

### 1 Select the band (FM1 – 3, AM) you want to store stations into (in this example, FM1).

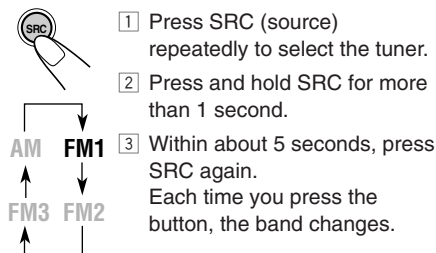

### 2 Tune in to a station (in this example, of 92.5 MHz).

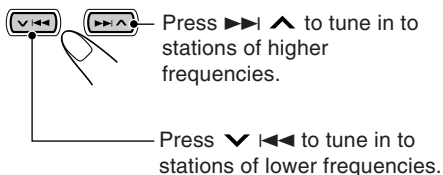

### 3 Press and hold the number button (in this example, 1) for more than 2 seconds.

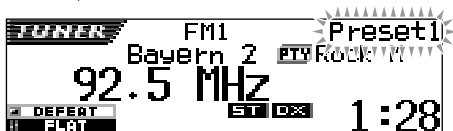
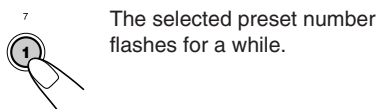

### 4 Repeat the above procedure to store other stations into other preset numbers.

## Notes:

- A previously preset station is erased when a new station is stored in the same preset number.
- Preset stations are erased when the power supply to the memory circuit is interrupted (for example, during battery replacement). If this occurs, preset the stations again.

## Tuning in to a preset station

You can easily tune in to a preset station. Remember that you must store stations first. If you have not stored them yet, see “Storing stations in memory” on pages 12 and 13.

### Selecting a preset station directly

#### 1 Select the band (FM1 – 3, AM).

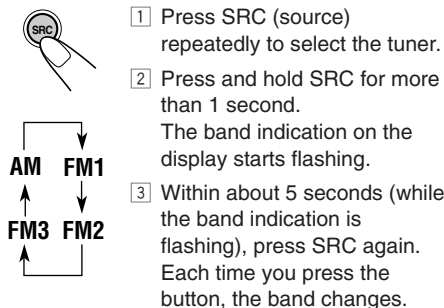

#### 2 Select the number (1 – 6) for the preset station you want.

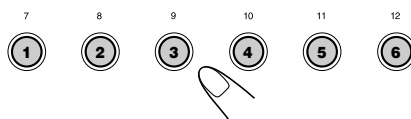



## Selecting a preset station using the preset station list

If you forget what stations are stored in what preset numbers, you can check the preset station list, then select your desired station on the list.

### 1 Select the band (FM1 – 3, AM).

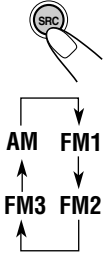

- 1 Press SRC (source) repeatedly to select the tuner.
- 2 Press and hold SRC for more than 1 second.
- 3 Within about 5 seconds, press SRC again. Each time you press the button, the band changes.

### 2 Press and hold ▲ (up) or ▼ (down) until the preset station list for the current band (FM1, FM2, FM3, or AM) appears on the display.

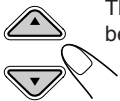

The currently received station will be highlighted on the display.

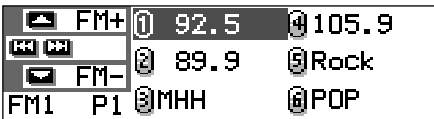

**Notes:**

- If one of FM band preset station lists (FM1, FM2, or FM3) is shown on the display, you can show the other lists by pressing ▲ (up) or ▼ (down).
- If a preset station is an FM RDS station with PS signal, PS name will be shown instead of the station frequency.

### 3 Select the number (1 – 6) for the preset station you want.

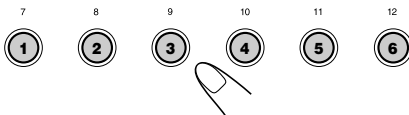

## Changing the display pattern

By pressing DISP (D), you can change the information shown on the display.



Each time you press the button, the display patterns change as follows:

• Initial display pattern:



• Programme station (PS) name is emphasized:



\*1 "No Name" always appears for AM or FM non-RDS stations (see the following pages).

\*2 Appears only when selecting a preset station.

\*3 PTY code appears only when receiving an RDS station.



## What you can do with RDS

RDS (Radio Data System) allows FM stations to send an additional signal along with their regular programme signals. For example, the stations send their station names, as well as information about what type of programme they broadcast, such as sports or music, etc.

Another advantage of RDS function is called "Enhanced Other Networks." By using the Enhanced Other Networks data sent from a station, you can tune in to a different station of a different network broadcasting your favorite programme or traffic announcement while listening to another programme or to another source such as CD.

By receiving the RDS data, this unit can do the following:

- Tracing the same programme automatically (Network-Tracking Reception)
- Standby Reception of TA (Traffic Announcement) or your favorite programme
- PTY (Programme Type) search
- Programme search
- And some other functions

### Tracing the same programme automatically (Network-Tracking Reception)

When driving in an area where FM reception is not good, the tuner built in this unit automatically tunes in to another RDS station, broadcasting the same programme with stronger signals. So, you can continue to listen to the same programme in its finest reception, no matter where you drive. (See the illustration on page 21.)

Two types of the RDS data are used to make Network-Tracking Reception work correctly —PI (Programme Identification) and AF (Alternative Frequency).

Without receiving these data correctly from the RDS station you are listening to, Network-Tracking Reception will not operate.

## To use Network-Tracking Reception

You can select the different modes of network-tracking reception to continue listening to the same programme in its finest reception. When shipped from the factory, "AF" is selected.

- **AF:** Network-Tracking Reception is activated without Regionalization. With this setting, the unit switches to another station within the same network when the receiving signals from the current station become weak. (In this mode, the programme may differ from the one currently received.) The AF indicator lights up.
- **AF Reg:** Network-Tracking Reception is activated with Regionalization. With this setting, the unit switches to another station, within the same network, broadcasting the same programme when the receiving signals from the current station become weak. The REG indicator lights up.
- **Off:** Network-Tracking Reception is deactivated. Neither the AF nor the REG indicator lights up.



AF or REG indicator lights up.

#### Note:

If a DAB tuner is connected and Alternative Reception (for DAB services) is activated, Network-Tracking Reception is also activated ("AF") automatically. On the other hand, Network-Tracking Reception cannot be deactivated without deactivating Alternative Reception. (See page 69.)



- 1 Press and hold SEL (select) for more than 2 seconds so that one of the PSM items appears on the display. (PSM: see pages 47 and 48.)



- 2 Press number button 4 to select “TUNER”—Tuner category of the PSM settings.

The “PTY Stnby” (standby) setting screen appears on the display.

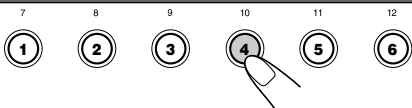

- 3 Select “AF-Regn’1” (alternative frequency/regionalization reception).



- 4 Select the desired mode—“AF,” “AF Reg,” or “Off.”

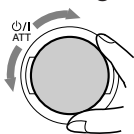

- 5 Finish the setting.



## Using TA Standby Reception

TA Standby Reception allows the unit to switch temporarily to Traffic Announcement (TA) from the current source (another FM station, CD, or other connected components).

- TA Standby Reception will not work if you are listening to an AM station.



Press T/P to activate TA Standby Reception.

Each time you press the button, this function is turned on and off alternately.



TP indicator appears (either lights up or flashes)

- When the DAB tuner is connected, this also turns on and off Road Traffic Flash Standby Reception (see page 66).

■ When the current source is FM, the TP indicator either lights up or flashes.

- If the TP indicator lights up, TA Standby Reception is activated.

If a station starts broadcasting a traffic announcement, “Traffic Flash” appears on the display, and this unit automatically tunes in to the station. The volume changes to the preset TA volume level (see page 20) and the traffic announcement can be heard.

- If the TP indicator flashes, TA Standby Reception is not yet activated since the station being received does not provide the signals used for TA Standby Reception. To activate TA Standby Reception, you need to tune in to another station providing these signals. Press ►►► ▲ or ▼ ◄◄◄ to search for such a station.

When a station providing these signals is tuned in, the TP indicator stops flashing and remains lit. Now TA Standby Reception is activated.





- **When the current source is other than FM,** the TP indicator lights up. If a station starts broadcasting a traffic announcement, “Traffic Flash” appears on the display, and this unit automatically changes the source and tunes in to the station.

### Using PTY Standby Reception

PTY Standby Reception allows the unit to switch temporarily to your favorite programme (PTY: Programme Type) from any source except AM stations.

#### To select your favorite PTY code for PTY Standby Reception

When shipped from factory, PTY Standby Reception has been set to work for searching for “News” programmes.

You can select your favorite programme type for PTY Standby Reception.

- 1 Press and hold SEL (select) for more than 2 seconds so that one of the PSM items appears on the display.** (PSM: see pages 47 and 48.)



- 2 Press number button 4 to select “TUNER”—Tuner category of the PSM settings.**

The “PTY Stnby” (standby) setting screen appears on the display.

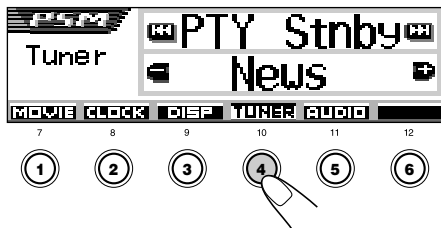

- 3 Select one of the twenty-nine PTY codes. (See page 21.)**

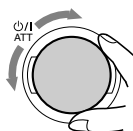

Selected code name appears on the display and is stored into memory.

- 4 Finish the setting.**



#### To set PTY Standby Reception

When the DAB tuner is connected, the following operations will set PTY Standby Reception both for the FM tuner and the DAB tuner. (See page 69.)

- 1 Press MODE (M) while listening to an FM stereo broadcast.** “Mode” appears on the display, and the number buttons start flashing.





- 2 Press number button 3 repeatedly to activate PTY Standby Reception while “Mode” is still on the display.  
Each time you press the button, PTY Standby Reception turns on and off alternately.

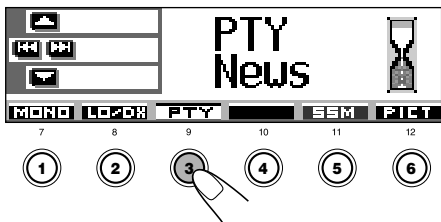

Ex.: When the currently selected PTY code for PTY Standby Reception is “News”

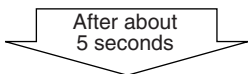

The display returns to the source indication screen.

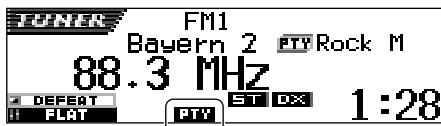

PTY indicator appears (either lights up or flashes)

The PTY indicator either lights up or flashes.

- If the PTY indicator lights up, PTY Standby Reception is activated.  
If a station starts broadcasting the selected PTY programme, this unit automatically tunes in to the station.
- If the PTY indicator flashes, PTY Standby Reception is not yet activated since the station being received does not provide the signals used for PTY Standby Reception.  
To activate PTY Standby Reception, you need to tune in to another station providing these signals. Press **▶▶** **▲** or **▼** **◀◀** to search for such a station.  
When a station providing these signals is tuned in, the PTY indicator stops flashing and remains lit. Now PTY Standby Reception is activated.

**Note:**

After turning on PTY Standby Reception, you can change the source without canceling PTY Standby Reception. In this case, the PTY indicator stops flashing if it was. If a station starts broadcasting the selected PTY programme, this unit automatically changes the source and tunes in to the station.

- If you change the source to AM, PTY Standby Reception will be temporarily canceled.
- You can only deactivate the PTY Standby Reception when the source is FM.

**Searching your favorite programme**

You can search any one of the PTY codes. In addition, you can store your 6 favorite programme types in the number buttons. When shipped from the factory, the following 6 programme types have been stored in the number buttons (1 to 6).

To store your favorite programme types, see below and page 19.

To search your favorite programme type, see page 19.

1	2	3
Pop M	Rock M	Easy M
4	5	6
Classics	Affairs	Varied

**To store your favorite programme types**

- 1 Press and hold T/P for more than 2 seconds while listening to an FM station.



The last selected PTY code appears.



## 2 Select one of the twenty-nine PTY codes. (See page 21.)

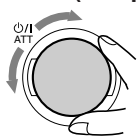

Selected code name appears on the display.

## 3 Press and hold the number button for more than 2 seconds to store the PTY code selected into the preset number you want.

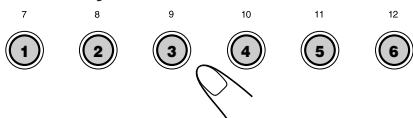

Selected preset number flashes for a while.

## 4 Press and hold T/P for more than 2 seconds to exit from this mode.



### To search your favorite programme type

## 1 Press and hold T/P for more than 2 seconds while listening to an FM station.

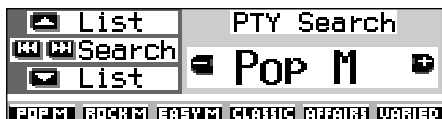

The last selected PTY code appears.

## 2 To select one of your favorite programme type

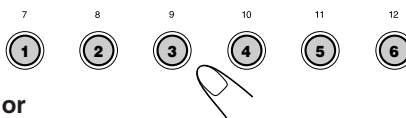

or

## To select any one of the twenty-nine PTY codes

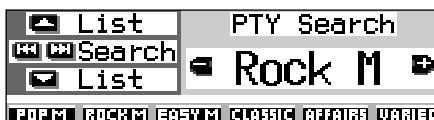
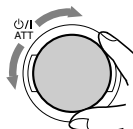

Ex.: When "Rock M" is selected

### How to use the ▲ (up) or ▼ (down) button

By pressing ▲ (up) or ▼ (down) repeatedly, you can show the list of your preset PTY codes and all twenty-nine PTY codes (six PTY codes at a time). First, the list of your stored PTY codes appears, then all twenty-nine PTY codes (six PTY codes at a time) appears in sequence. Press the number button to select your desired PTY code on the list currently shown on the display.

## 3 Start PTY search for your favorite programme.

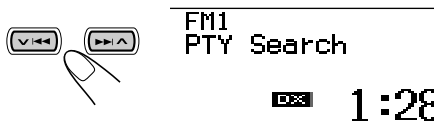

- If there is a station broadcasting a programme of the same PTY code as you selected, that station is tuned in.
- If there is no station broadcasting a programme of the same PTY code as you selected, the station will not change.

### Note:

In some areas, the PTY search will not work correctly.



## Other convenient RDS functions and adjustments

### Automatic selection of the station when using the number buttons

Usually when you press the number button, the preset station is tuned in.

However, when the preset station is an RDS station, something different will happen. If the signals from that preset station are not sufficient for good reception, this unit, using the AF data, tunes in to another frequency broadcasting the same programme as the original preset station is broadcasting. (Programme search)

- The unit takes some time to tune in to another station using programme search.

**To activate programme search**, follow the procedure below.

- See also “Changing the general settings (PSM)” on page 46.
- 1 Press and hold SEL (select) for more than 2 seconds so that one of the PSM items appears on the display.
  - 2 Press number button 4 to select “TUNER”—Tuner category of the PSM settings.
  - 3 Press ►►| ▲ or ▼ |◄◄ to select “P(Programme)-Search.”
  - 4 Turn the control dial clockwise to select “On.” Now programme search is activated.
  - 5 Press SEL (select) to finish the setting.

**To cancel programme search**, repeat the same procedure and select “Off” in step 4 by turning the control dial counterclockwise.

### Setting the TA volume level

You can preset the volume level for TA Standby Reception. When a traffic programme is received, the volume level automatically changes to the preset level.

- See also “Changing the general settings (PSM)” on page 46.
- 1 Press and hold SEL (select) for more than 2 seconds so that one of the PSM items appears on the display.
  - 2 Press number button 4 to select “TUNER”—Tuner category of the PSM settings.
  - 3 Press ►►| ▲ or ▼ |◄◄ to select “TA Volume.”
  - 4 Turn the control dial to set to the desired volume.  
You can set it from “Volume 0” to “Volume 50.”
  - 5 Press SEL (select) to finish the setting.

### Automatic clock adjustment

When shipped from the factory, the clock built in this unit is set to be readjusted automatically using the CT (Clock Time) data in the RDS signal.

If you do not want to use automatic clock adjustment, follow the procedure below.

- See also “Changing the general settings (PSM)” on page 46.
- 1 Press and hold SEL (select) for more than 2 seconds so that one of the PSM items appears on the display.
  - 2 Press number button 2 to select “CLOCK”—Clock category of the PSM settings.
  - 3 Press ►►| ▲ or ▼ |◄◄ to select “Auto Adj” (adjustment).
  - 4 Turn the control dial counterclockwise to select “Off.”  
Now automatic clock adjustment is canceled.
  - 5 Press SEL (select) to finish the setting.

**To reactivate clock adjustment**, repeat the same procedure and select “On” in step 4 by turning the control dial clockwise.

#### **Note:**

*You must stay tuned to the same station for more than 2 minutes after setting “Auto Adj” to “On.” Otherwise, the clock time will not be adjusted. (This is because the unit takes up to 2 minutes to capture the CT data in the RDS signal.)*



## PTY codes

News:	News	Social:	Programmes on social activities
Affairs:	Topical programmes expanding on current news or affairs	Religion:	Programmes dealing with any aspect of belief or faith, or the nature of existence or ethics
Info:	Programmes which impart advice on a wide variety of topics	Phone In:	Programmes where people can express their views either by phone or in a public forum
Sport:	Sport events	Travel:	Programmes about travel destinations, package tours, and travel ideas and opportunities
Educate:	Educational programmes	Leisure:	Programmes concerned with recreational activities such as gardening, cooking, fishing, etc.
Drama:	Radio plays	Jazz:	Jazz music
Culture:	Programmes on national or regional culture	Country:	Country music
Science:	Programmes on natural science and technology	Nation M:	Current popular music from another nation or region, in that country's language
Varied:	Other programmes like comedies or ceremonies	Oldies:	Classic pop music
Pop M:	Pop music	Folk M:	Folk music
Rock M:	Rock music	Document:	Programmes dealing with factual matters, presented in an investigative style
Easy M:	Easy-listening music		
Light M:	Light music		
Classics:	Classical music		
Other M:	Other music		
Weather:	Weather information		
Finance:	Reports on commerce, trading, the Stock Market, etc.		
Children:	Entertainment programmes for children		

**The same programme can be received on different frequencies.**

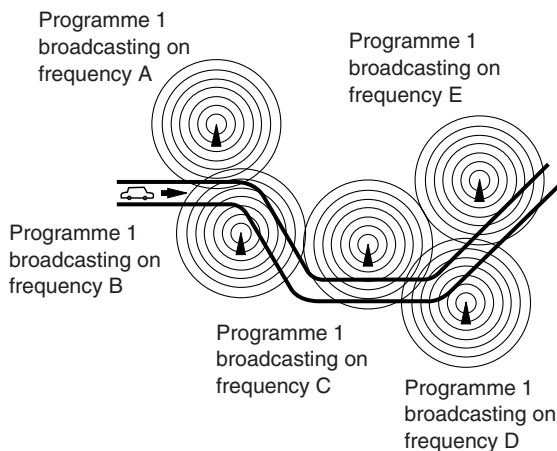



# CD OPERATIONS

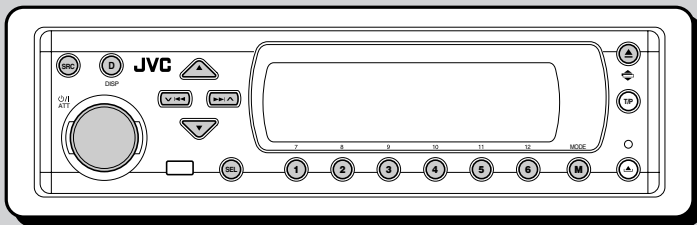

This unit has been designed to reproduce CDs, CD-Rs (Recordable), CD-RWs (Rewritable), and CD Texts.

- This unit is also compatible with MP3 and WMA discs. For details about these discs, refer to “A Guide to MP3/WMA” (separate volume).

## About MP3 and WMA discs

MP3 and WMA (Windows Media® Audio) “tracks” (word “file” is not used to indicate MP3 or WMA files, “track” is used in this manual) are recorded in “folders.”

During recording, the tracks and folders can be arranged in a way similar to arranging files and folders of computer data.

“Root” is similar to the root of a tree. Every track and folder can be linked to and be accessed from the root.

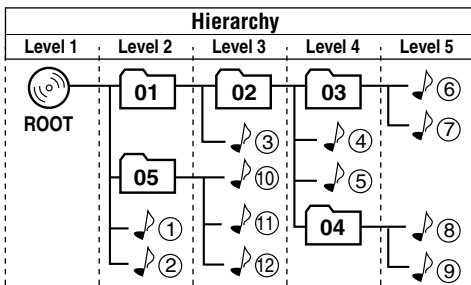

- 01** : Folders and their playback order
- ① : MP3/WMA tracks and their playback order

## Playing a disc

- 1 Open the control panel.

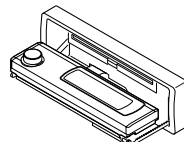

- 2 Insert a disc into the loading slot.

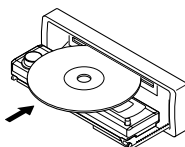

The unit draws the disc, the control panel goes back to the previous position (see page 52), and playback starts automatically.

All tracks will be played repeatedly until you stop playback.

### Notes:

- MP3 or WMA discs require a longer readout time. (It differs due to the complexity of the folder/track configuration.)
- For details on playable discs and other related information, see page 74.

## To stop play and eject the disc

Press .

Playback stops, the control panel moves down, and the disc automatically ejects from the loading slot.

If you change the source, the disc play also stops (without ejecting the disc this time).

• Microsoft and Windows Media are either registered trademarks or trademarks of Microsoft Corporation in the United States and/or other countries.



## • Display indications when inserting an audio CD or a CD Text:

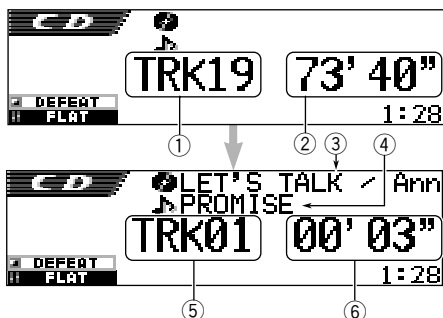

- ① Total track number
- ② Total playback time of the disc
- ③ Disc title/performer (if no title is recorded or assigned, "No Name" appears.)
- ④ Track title (if no title is recorded, "No Name" appears.)
- ⑤ Current track number
- ⑥ Elapsed playing time of the current track

\* If a name has been assigned to the audio CD (see page 51), it will be shown on the display.

## • Display indications when inserting an MP3 or a WMA disc

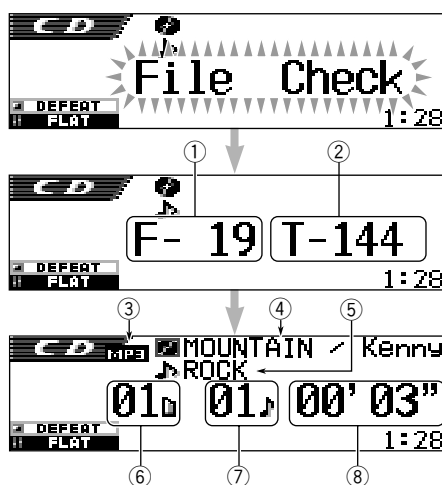

- ① Total folder number
- ② Total track number
- ③ Disc type—MP3 or WMA
- ④ Album name/performer (or folder name when "Tag" is set to "Off"—see page 49, or when no Tag is recorded)
- ⑤ Track title (or track name when "Tag" is set to "Off"—see page 49, or when no Tag is recorded)
- ⑥ Current folder number
- ⑦ Current track number
- ⑧ Elapsed playing time of the current track

### Notes:

- When a disc is already in the loading slot, selecting "CD" as the source starts disc play.
- The unit cannot read or play an MP3 track without the extension code <mp3>, and a WMA track without the extension code <wma>.
- When a disc is inserted upside down, the disc automatically ejects.
- If you change the source, playback also stops (without ejecting the disc).  
Next time you select "CD" as the source, disc play starts from where it has been stopped previously.

### Note:

If the ejected disc is not removed within 15 seconds, the disc is automatically inserted again into the loading slot to prevent it from dust. (Disc will not play this time.)

## To return the control panel to its previous position, press again.

- If you keep the loading slot open for about 1 minute, (beeps sound when the "Beep" setting is turned "On"—see page 49) the control panel returns to its previous position.  
Be careful not to get the disc or your finger caught in between the control panel and the unit.



### What is ImageLink

When an MP3 or a WMA folder includes an image <jml> file edited by Image Converter (supplied in the CD-ROM), you can show the image on the display while the tracks in the folder are played back.

- While reading an image <jml> file, no sounds come out (the preset image of a coffee cup is shown on the display during this period).

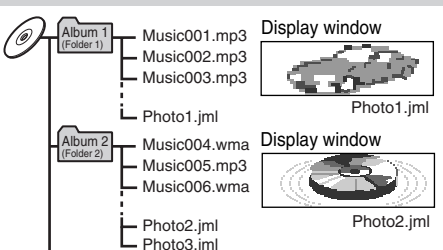

If there are more than one <jml> file in a folder, a <jml> file with younger playback order number will be shown on the display (in the above example, "Photo2.jml" will be used for Album 2).

To activate ImageLink, follow the procedure below

- See also "Changing the general settings (PSM)" on page 46.
- 1 Press and hold SEL (select) for more than 2 seconds so that one of the PSM items appears on the display.
  - 2 Press number button 1 to select "MOVIE" — Movie category of the PSM settings. The "Graphics" setting screen appears on the display.
  - 3 Turn the control dial to select "ImageLink."
  - 4 Press SEL (select) to finish the setting. ImageLink starts functioning when the next folder starts playing.

**Note:**

ImageLink will not work in the following cases:

- If no <jml> file is included in an MP3/WMA folder.
- If Intro Scan is activated.
- If the source is changed to another from "CD," or
- If you turn off then on the unit while the preset image of a coffee cup is shown on the display.

## Locating a particular portion on a track

### To fast-forward or reverse the track

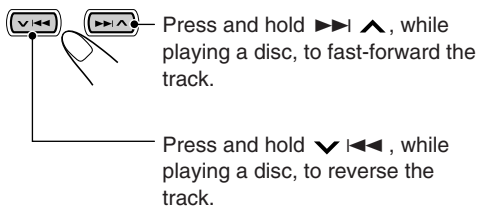

**Note:**

During this operation on an MP3 or WMA disc, you can only hear intermittent sounds. (The elapsed playing time also changes intermittently on the display.)

### To go to the next or previous tracks

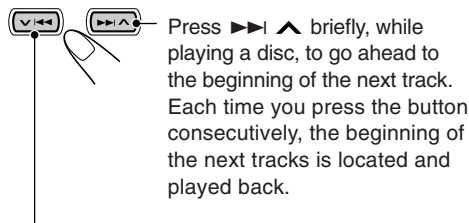

Press v <<< briefly, while playing a disc, to go back to the beginning of the current track. Each time you press the button consecutively, the beginning of the previous tracks is located and played back.





## Locating a track on a disc

### To go to a particular track directly (ONLY for CD and CD Text discs)

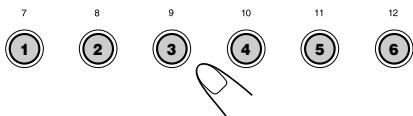

Press the number button corresponding to the track number to start its playback.

- To select a track number from 1 – 6:  
Press 1 (7) – 6 (12) briefly.
- To select a track number from 7 – 12:  
Press and hold 1 (7) – 6 (12) for more than 1 second.

### To go to a track quickly

- 1 Press MODE (M) while playing a disc.

“Mode” appears on the display, and the number buttons and ▲ (up)/ ▼ (down) buttons start flashing.

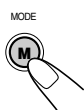

While playing an audio CD or a CD Text disc:

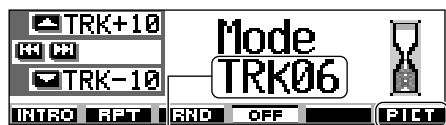

Current track number

See page 40 for this function.

While playing an MP3 or a WMA disc:

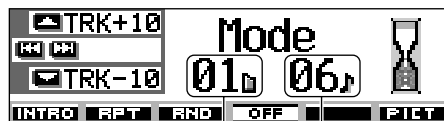

Current folder number

Current track number

- 2 Press ▲ (up) or ▼ (down), while “Mode” is still on the display. First time you press ▲ (up) or ▼ (down), the track skips to the nearest higher or lower track with a track number of multiple ten (ex. 10th, 20th, 30th).



Then, each time you press the button, you can skip 10 tracks (see “How to go to the desired track quickly” that follows).

- After the last track, the first track will be selected, and vice versa.
- While playing an MP3 or a WMA disc, this operation is possible only within a folder.

### How to go to the desired track quickly

- Ex. 1: To select track number 32 while playing track number 6

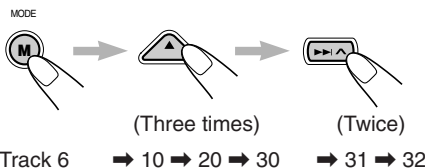

- Ex. 2: To select track number 8 while playing track number 36





## Locating a folder on a disc

The following operations are only possible when playing an MP3 or a WMA disc.

### To go to a folder directly

#### IMPORTANT:

To directly select the folders using the number button(s), it is required that folders are assigned 2 digit numbers at the beginning of their folder names. (This can only be done during the recording of CD-Rs or CD-RWs.)

Ex.: If folder name is "01 ABC"

→ Press 1 to go to Folder "01 ABC."

If folder name is "1 ABC," pressing 1 does not work.

If folder name is "12 ABC"

→ Press and hold 6 (12) to go to Folder "12 ABC."

Press the number button corresponding to the folder number to start playing the first track in the selected folder.

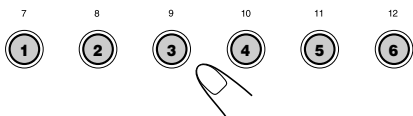

- To select a folder number from 01 – 06: Press 1 (7) – 6 (12) briefly.
- To select a folder number from 07 – 12: Press and hold 1 (7) – 6 (12) for more than 1 second.

#### Notes:

- If the folder does not contain any MP3 or WMA tracks, playback will not start ("No Music" appears on the display). Select another folder.
- You cannot directly select a folder with a number greater than 12.

To select a particular track in a folder, press ►| ▲ or ▼ |◄◄ after selecting the folder.

### To skip to the next or previous folder (either on the same or different hierarchy levels)

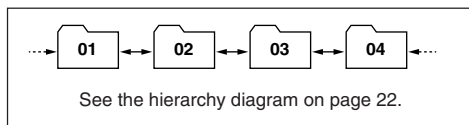

#### On the control panel:



Press ▲ (up) while playing a disc to skip to the next folder.

Each time you press the button consecutively, the next folder is located and the first track in the folder starts playing.

Press ▼ (down) while playing a disc to skip back to the previous folder.

Each time you press the button consecutively, the previous folder is located and the first track in the folder starts playing.

#### On the remote controller:

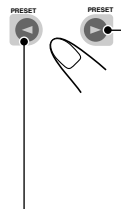

Press and hold ► (right) while playing a disc to skip to the next folder.

Each time you press and hold the button consecutively, the next folder is located and the first track in the folder starts playing.

Press and hold ◀ (left) while playing a disc to skip back to the previous folder.

Each time you press and hold the button consecutively, the previous folder is located and the first track in the folder starts playing.

#### Note:

If the folder does not contain any MP3 or WMA tracks, it is skipped.



## To skip to the next or previous folder within a folder (on the same hierarchy level)

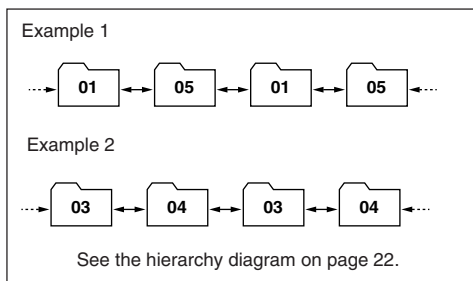

## To skip to the folders on the lower or on the higher hierarchy levels

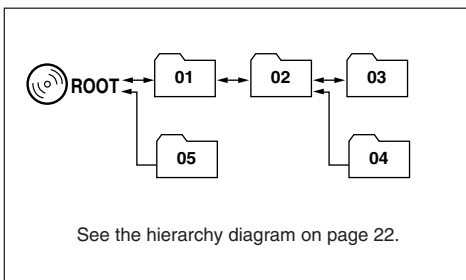

### ONLY on the remote controller:

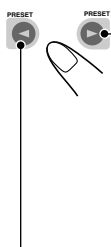

Press ► (right) while playing a disc to skip to the next folder. Each time you press the button consecutively, the next folder included within the same folder (on the same hierarchy level) is located (and the first track in the folder starts playing if recorded).

Press ◀ (left) while playing a disc to skip back to the previous folder.

Each time you press the button consecutively, the previous folder included within the same folder (on the same hierarchy level) is located (and the first track in the folder starts playing if recorded).

#### **Note:**

If the folder does not contain any MP3 or WMA tracks, playback will not start (“No Music” appears on the display). Select another folder.

### ONLY on the remote controller:

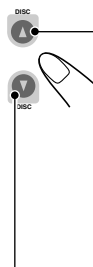

Press ▲ (up) while playing a disc to skip to a folder on the higher hierarchy level.

Each time you press the button consecutively, a folder on the higher hierarchy level is located (and the first track in the folder starts playing if recorded).

Press ▼ (down) while playing a disc to skip to a folder on the lower hierarchy level.

Each time you press the button consecutively, a folder on the lower hierarchy level is located (and the first track in the folder starts playing if recorded).

- If there are more than one folder on the lower or higher hierarchy level, a folder with younger playback order number will be located.

#### **Note:**

If the folder does not contain any MP3 or WMA tracks, playback will not start (“No Music” appears on the display). Select another folder.

**To go back to the root directly**, press **R•D** on the remote controller. You can go back to the root from any folder.

- If tracks are recorded on the disc directly without putting them into a folder, this unit starts playing the tracks.



## Selecting a folder and a track using the name lists

The following operations are only possible when playing an MP3 or a WMA disc.

You can show the folder name and track name lists on the display while playing a disc, then select a folder or a track you want to play.

### To select a folder and start playback

- 1 Press and hold ▲ (up) or ▼ (down) so that the folder name list of the inserted disc appears on the display.

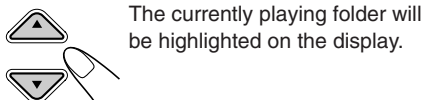

**Notes:**

- The display can show only six names at a time. You can show the other names on the next lists by pressing ▲ (up) or ▼ (down).
- If you press ►► ▲ or ▼ ◄◄, the track name list of the current playing folder appears. Each time you press the button, the folder name list and track name list alternately appears.
- Only folders including MP3 or WMA tracks will be listed.

- 2 Select the number (1 – 6) for the folder you want to play.

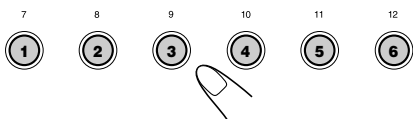

### To select a track and start playback

- 1 Press and hold ▲ (up) or ▼ (down) so that the folder name list of the inserted disc appears on the display.

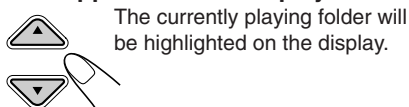

- 2 Show the track name list of the current folder.

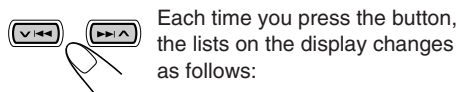

Folder name list ↔ Track name list

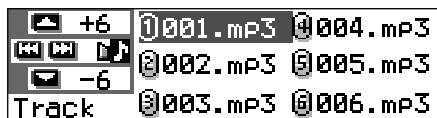

The currently playing track (or folder) will be highlighted on the display.

**Note:**

The display can show only six names at a time. You can show the other names on the next lists by pressing ▲ (up) or ▼ (down).

- 3 Select the number (1 – 6) for the track you want to play.

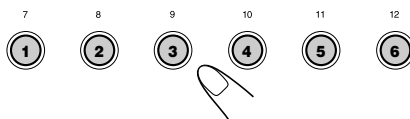



## Selecting playback modes

### To play back tracks at random (Random Play)

You can play back tracks on a disc (or in a folder for MP3 and WMA discs) at random.

- 1 Press MODE (M) while playing a disc.  
“Mode” appears on the display, then the number buttons and the ▲ (up)/▼ (down) buttons start flashing.

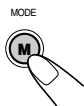

While playing an audio CD or a CD Text disc:

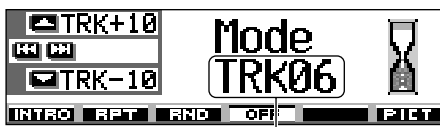

Current track number

While playing an MP3 or a WMA disc:

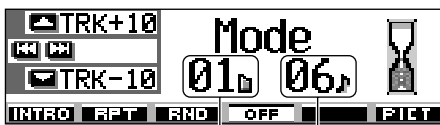

Current folder number

Current track number

- 2 Press number button 3, while “Mode” is still on the display.  
Each time you press the button, random play mode changes as follows:

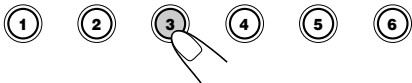

For audio CD and CD Text discs:

Random Disc ↔ Random Off

For MP3 and WMA discs:



Mode	Plays randomly
<b>Random Folder*</b> :	All tracks of the current folder, then moves to the next folder and so on. <ul style="list-style-type: none"> <li>• While playing,  RND lights up on the display.</li> </ul>
<b>Random Disc</b> :	All tracks on the disc. <ul style="list-style-type: none"> <li>• While playing,  RND lights up on the display.</li> </ul>

\* “Random Folder” can be used for MP3 and WMA discs only.

To cancel Random Play, select “Random Off” by pressing number button 3 repeatedly or press number button 4 in step 2.

### To play back tracks repeatedly (Repeat Play)

You can play back a track (or a folder for MP3 and WMA discs) repeatedly.

- 1 Press MODE (M) while playing a disc.  
“Mode” appears on the display, then the number buttons and the ▲ (up)/▼ (down) buttons start flashing.
- 2 Press number button 2, while “Mode” is still on the display.  
Each time you press the button, repeat play mode changes as follows:

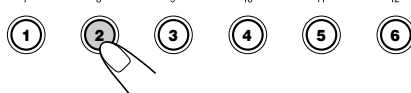
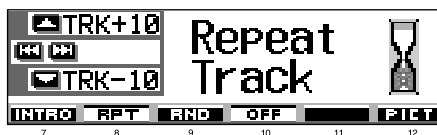



For audio CD and CD Text discs:

Repeat Track ↔ Repeat Off

For MP3 and WMA discs:



For audio CD and CD Text discs:

Intro Track ↔ Intro Off

For MP3 and WMA discs:



Mode	Plays repeatedly
------	------------------

**Repeat Track :** Current (or specified) track.

- While playing, lights up on the display.

**Repeat Folder\*:** All tracks of the current (or specified) folder.

- While playing, lights up on the display.

\* "Repeat Folder" can be used for MP3 and WMA discs only.

To cancel Repeat Play, select "Repeat Off" by pressing number button 2 repeatedly or press number button 4 in step 2.

### To play back only intros (Intro Scan)

You can play back the first 15 seconds of each track sequentially.

1 Press MODE (M) while playing a disc.

"Mode" appears on the display, then the number buttons and the ▲ (up)/▼ (down) buttons start flashing.



2 Press number button 1, while "Mode" is still on the display.

Each time you press the button, intro scan mode changes as follows:



Mode	Plays the beginnings of
------	-------------------------

**Intro Track :** All tracks of the disc.

- While playing, lights up on the display.

**Intro Folder\* :** First tracks of all folders.

- While playing, lights up on the display.

\* "Intro Folder" can be used for MP3 and WMA discs only.

To cancel Intro Scan, select "Intro Off" by pressing number button 1 repeatedly or press number button 4 in step 2.

### Prohibiting disc ejection

You can prohibit disc ejection and can lock a disc in the loading slot.

While pressing SEL (select), press and hold ▲ for more than 2 seconds.

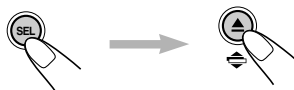

"No Eject" flashes on the display for about 5 seconds, and the disc is locked and cannot be ejected.

**To cancel the prohibition and unlock the disc**

While pressing SEL (select), press and hold ▲ again for more than 2 seconds.

"Eject OK" flashes on the display for about 5 seconds, and the disc is unlocked.



## Changing the display pattern

By pressing DISP (D), you can change the information shown on the display.



Each time you press the button, the display patterns change as follows:

While playing an audio CD or a CDText disc:

- Initial display



- Disc title/performer or your assigned disc name is emphasized:



- Track title is emphasized:



- Clock time is emphasized:



While playing an MP3 or a WMA disc:

- Initial display



- Album name/performer or folder name is emphasized:



- Track title or track name is emphasized:



- Clock time is emphasized:



### Notes:

\*1 If "Tag" is set to "Off" (see page 49), folder name appear with

\*2 If "Tag" is set to "Off" (see page 49), track name appear with

### Notes:

\*1 If no name is assigned to the audio CD, or if no disc title/performer is recorded for the CD Text, "No Name" will appear.

To assign a name to an audio CD, see page 51.

\*2 "No Name" appears for an audio CD. If no track title is recorded for the CD Text, "No Name" will also appear.

### Display indication:

- When the title is emphasized at the center of the display, it is shown entirely by scrolling if it cannot be shown at a time. See also "To select the scroll mode—Scroll" on page 48.
- Some characters or symbols will not be shown (will be blanked or substituted) on the display.



# DSP OPERATIONS

## Selecting the DSP modes

Using the DSP (Digital Signal Processor) modes built in this unit, you can create a more acoustic sound field in your car compartment.

### Available DSP modes:

- THEATER:** Reminds you of the intensity reproducing a theater.
- HALL:** Reminds you of a large concert hall with a being-there feeling.
- CLUB:** Reminds you of powerfulness reproduced in a dance club.
- DOME:** Reminds you of a dome with a high ceiling.
- STUDIO:** Reminds you of live sounds in a recording studio.
- V. CANCEL:** Reduces the vocal sounds (Voice Cancel). Good for mastering your favorite songs—Karaoke.
- DEFEAT:** Cancels the DSP modes.

### Note:

Effectiveness of "V.CANCEL" depends on the recording condition of the sources. Especially, if you play back the following sources you cannot get the satisfactory results.

- Monaural sources such as AM and monaural FM broadcasting programs,
- Multiplex sound sources, and
- Sources recorded with duets, strong echo, a chorus, or only a few instruments.

## 1 Press SEL (select) once to show the DSP mode selection screen.



The last selected DSP mode screen appears.



- If you press the button twice or more, the unit enters different sound adjustment modes.

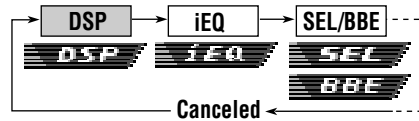

- For iEQ (sound mode) settings, see pages 35 and 36.
- For SEL/BBE (basic sound) settings, see pages 37 and 38.

## 2 Press the number button to select one of the DSP modes listed on the display.

- This unit has two DSP mode selection screens. To move to the other screen, press ▲ (up) or ▼ (down).



Press ▲ (up) or ▼ (down).







### 3 Adjust the DSP effect level—1, 2, or 3.

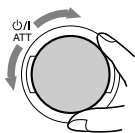

The selected DSP effect level is valid for all DSP modes except "V.CANCEL."

- As the number increases, the effect level becomes stronger.



Ex. When "Dome" is selected in the previous step

### To make further precise settings for the DSP modes

You can also make further precise settings to make the best sound field in your car compartment. These settings you make are valid for all DSP modes except "V.CANCEL."

#### Setting items:

##### The number of the built-in speakers :

Select the number of the speakers built in your car—"2ch" or "4ch."

- When you have four speakers (4ch) built in your car, select your car size (see step 5 on page 34).

##### Listening seat position:

Select the listening seat position where you want to locate the sound image.

To cancel the DSP modes, select "DEFEAT" in step 2.

To exit from the DSP mode selection screen, press SEL (select) repeatedly or wait for about 15 seconds.

### 1 Press SEL (select) once to show the DSP mode selection screen.

The currently activated DSP mode appears on the display.



Ex. When "Dome" is selected previously

- If the DSP mode is not activated ("DEFEAT" is selected), you cannot go to the next step. Select one of the DSP modes first.



**2** Press number button 6 to enter the further precise setting screen.



**3** Select your listening seats position.

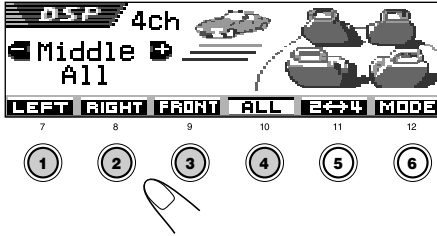

- Press **number button 1** to select “LEFT (front left)” seat.
- Press **number button 2** to select “RIGHT (front right)” seat.
- Press **number button 3** to select “FRONT” seats.
- Press **number button 4** to select “ALL” seats.

**Note:**

*If fader or balance has been set close to its extreme, appropriate effect may not be obtained.*

**4** Press number button 5 to set the number of the built-in speakers.



- Select “**4ch**” for the four speaker system, and “**2ch**” for the two speaker system.

**Note:**

*When “4ch” is selected, rear speakers are used only to reproduce reflections and reverberations in order to create a being-there feeling in your car compartment.*

**5** If you select “4ch,” rotate the control dial to select your car size.

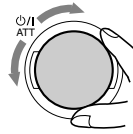

As you rotate it, the car size changes as follows:

**Compact ↔ Middle ↔ Large**

- **Compact:** Select when the distance from the rear speakers to the listening seat position is shorter than that from the front speakers.
- **Middle:** Select when the distance from the rear speakers to the listening seat position is almost equal to that from the front speakers.
- **Large:** Select when the distance from the rear speakers to the listening seat position is longer than that from the front speakers.

**Note:**

*If you have selected “2ch” in the previous step, you cannot select the car size.*

**To go back to the DSP mode selection screen,** press number button 6.

**To exit from the DSP mode selection screen,** press SEL (select) repeatedly or wait for about 15 seconds.



## Selecting preset sound modes (iEQ: intelligent equalizer)

You can select a preset sound mode (iEQ: intelligent equalizer) suitable to the music genre.

### Available sound modes:

- H. ROCK** (Hard Rock)
- R & B** (Rhythm and Blues)
- POP** (Popular music)
- JAZZ** (Jazz)
- DANCE** (Dance music)
- Country** (Country music)
- REGGAE** (Reggae)
- CLASSIC** (Classical music)
- USER 1, USER 2, USER 3**
- FLAT** (No sound mode is applied)

**2** Press the number button to select one of the sound modes listed on the display.

- This unit has two sound mode selection screens. To move to the other screen, press ▲ (up) or ▼ (down).

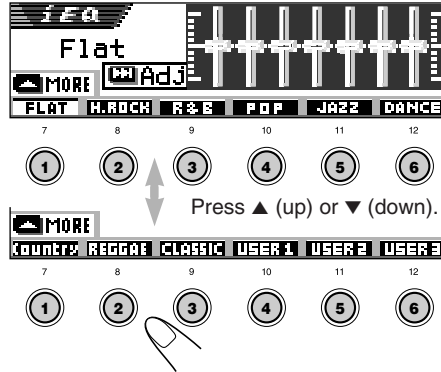

**1** Press SEL (select) twice to show the sound selection screen.



The last selected sound mode is called up.

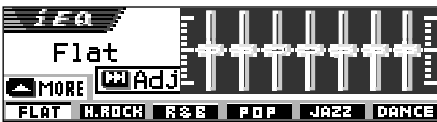

- If you press the button more than twice, the unit enters different sound adjustment modes.

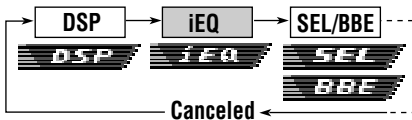

- For DSP mode settings, see pages 32 to 34.
- For SEL/BBE (basic sound) settings, see pages 37 and 38.

To cancel the sound mode, select “FLAT” in step 2.

To exit from the sound mode selection screen, press SEL (select) repeatedly or wait for about 15 seconds.

### Notes:

- For details about the preset settings of each sound mode, see page 71.
- If “V.CANCEL” is selected for the DSP mode, you cannot change the sound modes.



## Storing your own sound modes

You can adjust the sound modes to your preference and store your own adjustments in memory (USER 1, USER 2 and USER 3).

- 1 Press SEL (select) twice to show the sound mode selection screen.**



The last selected sound mode is called up.

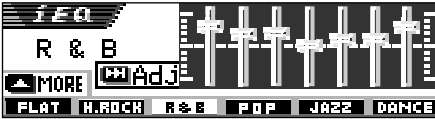

Ex. When "R & B" is selected previously

- 2 Press the number button to select one of the sound modes listed on the display.**

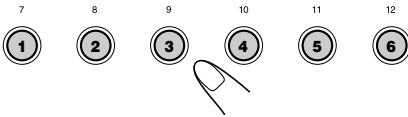

- This unit has two sound mode selection screens. To move to the other screen, press ▲ (up) or ▼ (down).

- 3 Enter the sound adjustment mode.**

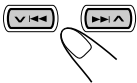

The following sound mode adjustment screen appears on the display.

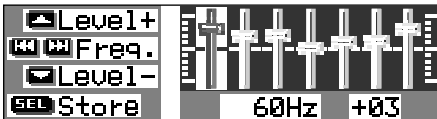

- 4 Make adjustments as you like.**

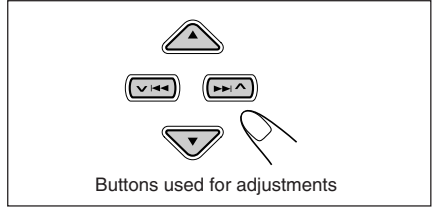

- Press ►► ▲ or ▼ ◀◀ to select the frequency band—60Hz, 150Hz, 400Hz, 1kHz, 2.4kHz, 6kHz, 12kHz.
- Press ▲ (up) or ▼ (down) to adjust the level of the selected band within the range of -05 to +05.
- Repeat steps 1) and 2) to adjust the other frequency bands.

- 5 Store the adjustment you made.**



The confirmation message appears—whether you want to store the adjustment.

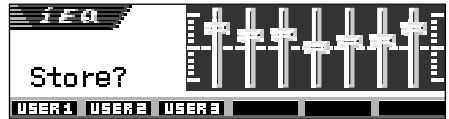

If you want to cancel the adjustment, press DISP (D).

- Adjustment you made remains effective until you select another sound mode.

- 6 Press number button 1, 2 or 3 to select one of the user sound modes (USER 1, USER 2, or USER 3) you want to store into.**

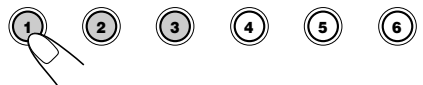
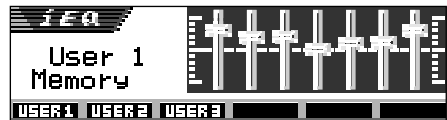

Ex. When you select "USER 1."



## Performing the basic sound settings

You can set the speaker output balance, subwoofer output level, and input level of each source.

- There is a time limit in doing the following procedure. If the setting is canceled before you finish, start from step 1 again.

### 1 Press SEL (select) repeatedly to show one of the basic sound setting (SEL) screens.



Each time you press the button, the adjustable items change as follows:

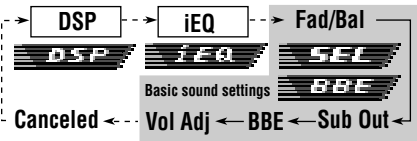

- For DSP mode settings, see pages 32 to 34.
- For iEQ (sound mode) settings, see pages 35 and 36.

Indication	To do:	Range
Fad	Adjust the front and rear speaker balance.	R06 (Rear only)   F06 (Front only)
Bal	Adjust the left and right speaker balance.	L06 (Left only)   R06 (Right only)
Sub Out	Adjust the subwoofer output level and cutoff frequency level.	00 (min.)   08 (max.) Low/Mid/High
BBE	Make sounds natural.	BBE Off, BBE 1, BBE 2, BBE 3
Vol Adj	Adjust and store the input level of each source.	-05 (min.)   +05 (max.)

### 2 Adjust the level.

**To adjust fader and balance—Fad, Bal:** Make these two adjustments at the same time.

- If you are using a two-speaker system, set the fader level to “00.”

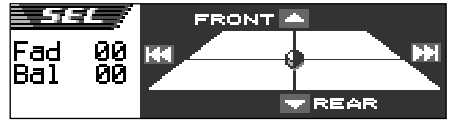
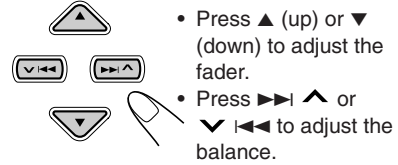

**To adjust subwoofer output—Sub Out:**

This takes effect only when a subwoofer is connected.

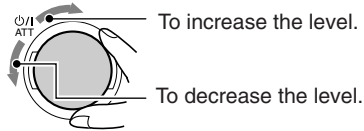

You can also set an appropriate cutoff frequency level according to the subwoofer connected.

- Press ►► ▲ or ▼ ◄◄ to select “Low,” “Mid,” or “High.”
- Low: Frequencies higher than 50 Hz are cut off to the subwoofer.
- Mid: Frequencies higher than 80 Hz are cut off to the subwoofer.
- High: Frequencies higher than 115 Hz are cut off to the subwoofer.



**To make sounds natural—BBE:**

BBE Digital\* is a new digital processing method to restore the brilliance and clarity of the original live sound in recording, broadcasts, etc.

When a speaker reproduces sound, it introduces frequency-dependent phase shifting, causing high-frequency sounds to take longer to reach the ear than low frequency sounds. BBE Digital adjusts the phase relationship between the low, mid and high frequencies by adding a progressively longer delay time to the low and mid frequencies, so that all frequencies reach the listener's ears at the proper time.

Select the effect level.

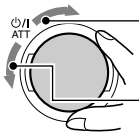

To increase the level.

To decrease the level.



**BBE Off ↔ BBE 1 ↔ BBE 2 ↔ BBE 3 (Canceled)**

As the number gets higher, the effect level becomes stronger.

When shipped from the factory, the effect level is set to "BBE Off" (BBE Digital is canceled).

**Note:**

If "V.CANCEL" is selected for the DSP mode, you cannot change the BBE level.

\* Manufactured under license from BBE Sound, Inc.

Licensed by BBE Sound, Inc. under USP4638258 and 4482866. BBE and BBE symbol are registered trademarks of BBE Sound, Inc.

**To adjust the input level of each source —Vol Adj:**

This setting is required for each source except FM. Before making an adjustment, select an appropriate source for which you want to make an adjustment.

Once you have made an adjustment, it is memorized, and you will not need to adjust the volume level each time you change the source.

Adjust to match the input level to the FM sound level.

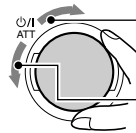

To increase the level.

To decrease the level.

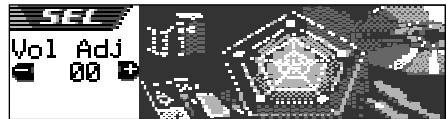

**If the INPUT OVER (INPUT OVER) indicator appears on the display, and sounds are distorted**

The input level through the external component (LINE IN) is set at a high level (more than 1.5 Vrms).

If this happens, adjust the output level on the connected component so that the INPUT OVER (INPUT OVER) indicator will not appear.



INPUT OVER (INPUT OVER) indicator

With Image Converter included in the supplied CD-ROM, you can edit your own favorite pictures and use them as your own opening screen, ending screen, and graphic screen while playing a source.



## What is Image Converter

Image Converter is a JVC's original software to produce a custom image to show on your JVC Car Audio.

## Here is a basic procedure to make a CD-R including still images (pictures) and animations (movies) with Image Converter

In this manual, we only explain how to export the files (still images and animations) into the memory built in this unit—step 5 below.

- For the other processes (from steps 1 to 4 below), refer to Image Converter manual (PDF files included in the "Manual" folder of the supplied CD-ROM).

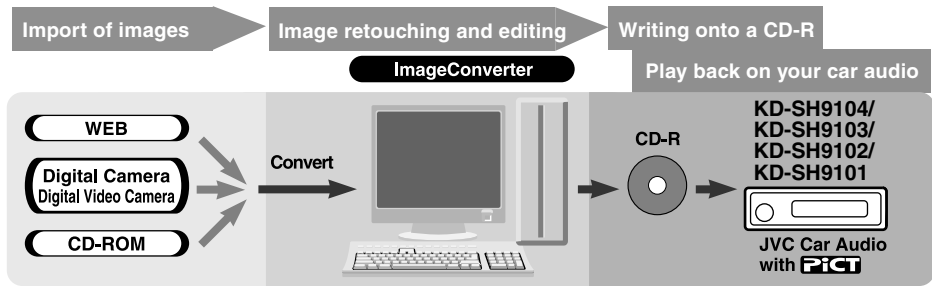

### 1 Install / Start the program

Install Image Converter on your PC.

### 2 Import the images

Import the source images from the Image Converter CD-ROM or from other equipment like a digital camera or a digital video camera.

### 3 Retouch and edit the images

Retouch the images like trimming or adjusting the color, editing the animation effect, and adding the texts.

### 4 Write your images onto a CD-R

Write the animations or the still images you made with Image Converter using your CD-R writing software.

You have to write the images you made onto a CD-R to enjoy the images on your Car Audio.

- To write data onto a CD-R, refer also to the instruction of your CD-R writing software.

### 5 Enjoy the animations or the still images you made on your Car Audio

Export the images to your JVC Car Audio from the CD-R you made.

# Downloading images and animations

Before starting the following procedure, prepare a CD-ROM including still images (pictures) and animations (movies).

- The supplied Image Converter CD-ROM includes sample images and animations, so you can use this disc as your first trial.

**IMPORTANT:**

- Still images (pictures) should have <jml>, and animations (movies) should have <jma> as their extension code in their file names.
- Downloading a file can be done only while selecting "CD" as the source; on the other hand, deleting a file can be done while selecting any source.
- Before you download or erase the files, observe the following:
  - Do not download a file while driving.
  - Do not turn off the ignition key of the car while downloading or erasing a file.\*
  - Do not detach the control panel while downloading or erasing a file.\*
- \* If you do it, the file download or erasure will not be done correctly. In this case, perform the same procedure again.
- If you have already downloaded an animation for "PowerOn," "PowerOff," or "Movie," downloading a new animation deletes the previously stored animation.
- It takes a long time for the unit to download an animation.
  - About 6 to 7 seconds for a still image (one frame).
  - About 3 to 4 minutes for an animation of 30 frames.
  - About 10 minutes for an animation of 90 frames.
- While a station (or service for the DAB tuner) is being tuned in by one of the Standby Reception modes such as TA, PTY, or Announcement, you cannot download or delete a file. On the other hand, while you are downloading or deleting a file, no Standby Reception mode will work to have this unit tune in a station (or service). It only works after download or deletion is over.

## 1 Open the control panel.

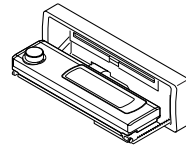

## 2 Insert a CD-ROM with the files (images and animations) into the loading slot.

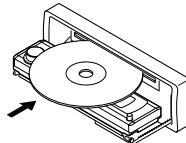

The unit draws the disc, the control panel goes back to the previous position (see page 52).

- If the disc includes playable audio files such as MP3 tracks, playback starts automatically.

## 3 Press MODE (M) after the disc is detected.



"Mode" appears on the display, then the number buttons and the ▲ (up)/▼ (down) buttons start flashing.

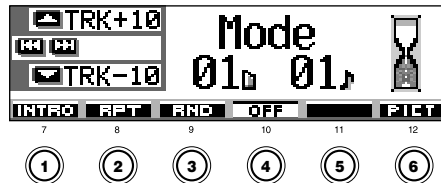

## 4 Press number button 6 to show the download selection screen.





## 5 Select (highlight) one of the listed items for which you want to download a file.

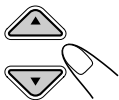

- **PowerOn** : Opening screen  
To download an animation to be shown after the unit is turned on. (You can store only one animation consisting of 30 frames maximum.)
- **PowerOff** : Ending screen  
To download an animation to be shown before the unit is turned off. (You can store only one animation consisting of 30 frames maximum.)
- **Picture** : Graphic screen\*  
To download a still image to be shown while playing a source. (You can store 90 still images—each one frame.)
- **Movie** : Graphic screen\*  
To download an animation to be shown while playing a source. (You can store only one animation consisting of 90 frames maximum.)

\* Graphic screen will appear only if no operation is done for about 20 seconds.

If you want to cancel the procedure, press number button 5, the download selection screen goes off.

## 6 Show the name list of the folder included in the inserted CD-R.



"File Check...." appears for a while, then the folder list appears.

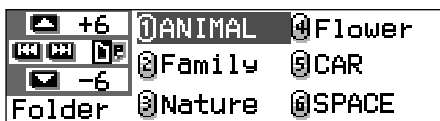

The currently selected folder will be highlighted on the display.

### Notes:

- On this list, the folders including the target files—<jml> files for "Picture" and <jma> files for the others—are shown.
- The display can show only six names at a time. You can show the other names on the next lists by pressing ▲ (up) or ▼ (down).
- If a disc inserted does not include any <jml> and <jma> files, beeps sound and you cannot go to the next step.

If you want to cancel the procedure, press DISP (D).

## 7 Select (highlight) a folder in which a file you want is included.

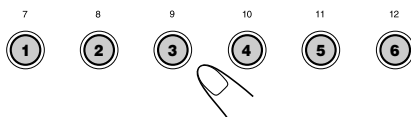

## 8 Show the name list of the files included in the selected folder.

Each time you press the button, the lists on the display changes as follows:

Folder name list ↔ File name list



Ex. When you have selected "Picture" in step 5.

### Note:

The display can show only six names at a time. You can show the other names on the next lists by pressing ▲ (up) or ▼ (down).

## 9 Select a file you want to download.

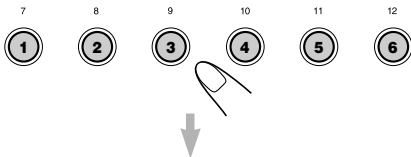

The file name appears, and the unit will ask you "Download OK?"

## 10 If it is OK, press number button 1 to start downloading.

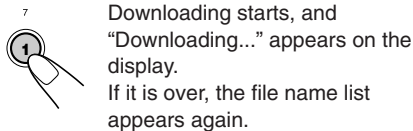

If it is not OK, press number button 5, the file selection screen appears again. Repeat from step 8 again.

## 11 Repeat steps 8 to 10 if you are downloading files for "Picture" and want to store more files.

## 12 Finish the download procedure.



To download a file for another item listed on the download selection screen, repeat from step 3 again.

### Notes:

- If you try to store the 91st image for picture screen, "Picture Full" appears and you cannot start downloading. In this case, delete unwanted files before downloading.
- If the total frame number of an animation downloaded exceeds the following number, the frames exceeding that numbers are ignored.
  - For opening and ending screens: 30
  - For movie screen: 90

## Deleting unwanted files

- When "BACK" is shown on the display above number button 5, you can go back to the previous screen by pressing number button 5.

### To delete all the stored files at a time

- 1 Press MODE (M) while playing any source. "Mode" appears on the display, and the number buttons and ▲ (up)/▼ (down) buttons start flashing.



- 2 Press number button 6 to show the download selection screen.



- 3 Press ▲ (up) or ▼ (down) to select (highlight) all the listed items.



- 4 Press number button 4. The unit asks you "All File Delete OK?"



- 5 Press number button 4 again. "Now Deleting..." appears while erasing the files. When erasure is over, the download selection screen appears again.



- 6 Press number button 5 to resume the source indication screen.



### To delete the files stored for “PowerOn,” “PowerOff,” “Picture (all stored images at a time),” and “Movie”

1 Press MODE (M) while playing any source.  
“Mode” appears on the display, and the number buttons and ▲ (up)/ ▼ (down) buttons start flashing.



2 Press number button 6 to show the download selection screen.



3 Press ▲ (up) or ▼ (down) to select (highlight) one of the listed items.  
Ex. When selecting “Picture”

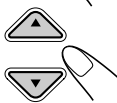

Appears when “Picture” is selected (highlighted)

4 To delete the file stored in “PowerOn,” “PowerOff,” and “Movie,” press number button 3.  
The file name of the previously stored animation appears, and the unit asks you “Delete OK?”

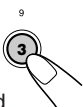

To delete all the files stored in “Picture” at a time, press number button 4.  
The unit asks you “All Picture Delete OK?”



5 To delete the file stored in “PowerOn,” “PowerOff,” and “Movie,” press number button 3 again.



To delete all the files stored in “Picture” at a time, press number button 4 again.



“Now Deleting...” appears while erasing the selected file. When erasure is over, the download selection screen appears again.

6 Press number button 5 to resume the source indication screen.

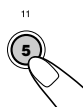

### To delete the stored files for “Picture” (one by one)

1 Press MODE (M) while playing any source.  
“Mode” appears on the display, and the number buttons and ▲ (up)/ ▼ (down) buttons start flashing.

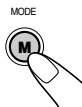

2 Press number button 6 to show the download selection screen.

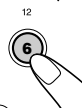

3 Press ▲ (up) or ▼ (down) to select (highlight) “Picture.”

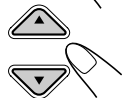

4 Press number button 3.  
The unit shows the name list of the stored files.

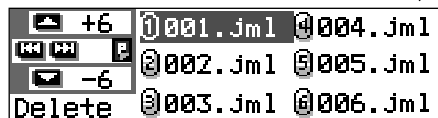

**Note:**  
The display can show only six names at a time. You can show the other names by pressing ▲ (up) or ▼ (down) repeatedly.

5 Press the number buttons for the file you want to delete.

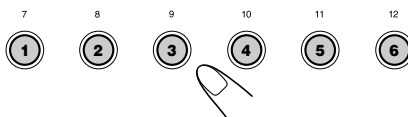

Selected file name appears, and the unit asks you “Delete OK?”

6 Press number button 3 to start erasure.  
“Now Deleting...” appears while erasing the selected file. When erasure is over, the name list of the stored file appears again.

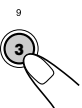

- To delete more files, repeat from steps 5 and 6.
- Press DISP (D) to resume the source indication screen.



## Activating the downloaded images and animations

### To activate the animations stored for opening and ending screens

After the unit turns on or before the unit turns off, you can see preset animations on the display. These are called opening screen and ending screen. You can use your own edited animations for these opening and ending screens.

- Opening and ending screens will not be shown if the "KeyIn CFM" setting is set to "Short" or "Off." (See page 48).
- If no animation is stored in "PowerOn" and "PowerOff," "Opening" and "Ending" will not be selected as a PSM item.

- Press and hold SEL (select) for more than 2 seconds so that one of the PSM items appears on the display. (PSM: see pages 47 and 48).



- Press number button 1 to select "MOVIE"—Movie category of the PSM settings.

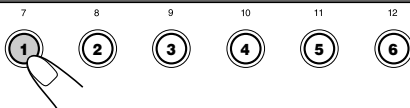

The "Graphics" setting screen appears on the display.

- Select "Opening" (opening screen setting) or "Ending" (ending screen setting).



Ex. When you select "Opening"

- Select "User."

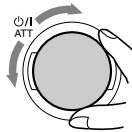

- Default: Factory-preset animation is used.
- User: Your own edited animation is used.

- Finish the setting.



### To activate the graphic screen using either picture or movie

Using this setting, you can change the graphic displays. These graphic screen appears if no operation is done for about 20 seconds.

- If no image is stored in "Picture," or no animation in "Movie," "UserPict." will not be selected as a PSM item.

- Press and hold SEL (select) for more than 2 seconds so that one of the PSM items appears on the display. (PSM: see pages 47 and 48.)



**2** Press number button 1 to select “MOVIE”—Movie category of the PSM settings.



The “Graphics” setting screen appears on the display.

**3** Select “UserMovie,” “UserSlide,” or “UserPict.”



Ex. When you select “UserPict.”

- UserMovie: Your edited animation stored in “Movie” is activated as your graphic screen.
- UserSlide: Your edited still images stored in “Picture” are activated and shown in sequence as your graphic screen.
- UserPict.: One of your edited still image stored in “Picture” is activated as your graphic screen. Select one of the stored images (see the next column).

**4** Finish the setting.



To cancel all graphic displays, select “Off” in step 3.

**Note:**

For the “Graphics” setting, you can also select “All Demo,” “Int Demo,” and “ImageLink.”

— See pages 8 and 48 for “All Demo” and “Int Demo.”

— See pages 24 and 48 for “ImageLink.”

**To select a still image for graphic display—User Picture**

You cannot select “UserPict.” as a PSM item in the following cases:

- If no image is stored in “Picture,” or
- “UserPict.” is not selected for the “Graphics” setting (see the left column).

**1** Press and hold SEL (select) for more than 2 seconds so that one of the PSM items appears on the display. (PSM: see pages 47 and 48.)



**2** Press number button 1 to select “MOVIE”—Movie category of the PSM settings.

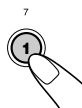

The “Graphics” setting screen appears on the display.

**3** Select “UserPict.”



File name of the currently selected image also appears.

**4** Select a file you want.



**5** Finish the setting.





# OTHER MAIN FUNCTIONS

## Changing the general settings (PSM)

You can change the items listed on the table on the next page by using the PSM (Preferred Setting Mode) control.

- The PSM items are grouped into five categories—MOVIE, CLOCK, DISP (display), TUNER, and AUDIO.

### Basic Procedure

Ex. To change "Contrast"

- 1 Press and hold SEL (select) for more than 2 seconds so that one of the PSM items appears on the display. (See pages 47 and 48.)**



The number buttons,  $\downarrow$   $\lll$  /  $\ggg$   $\uparrow$ , and control dial start flashing to teach you that they can be used for the next operational steps.

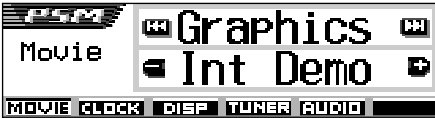

Ex. When you have selected "Graphics" previously

- 2 Press number button (in this example, 3) to select one of the PSM categories.**

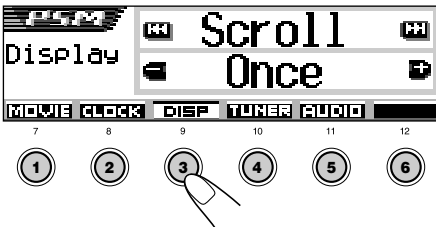

The first-listed item in the selected category appears.

- 3 Select the PSM item you want to adjust.**

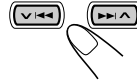

- By pressing  $\ggg$   $\uparrow$  or  $\downarrow$   $\lll$  repeatedly, you can also move to another category.

- 4 Adjust the PSM item selected.**

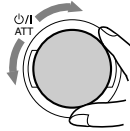

- 5 Repeat steps 2 to 4 to adjust the other PSM items if necessary.**

- 6 Finish the setting.**





## Preferred Setting Mode (PSM) items

		Indications	Selectable values	Initial settings	Page
MOVIE	<b>Graphics</b>	Movie demonstration	See page 48.	Int Demo	48
	<b>KeyIn CFM</b>	Key-in confirmation	Long ↔ Short ↙ Off ↘	Long	48
	<b>Opening<sup>*1</sup></b>	Opening animation	Default   User	Default	44
	<b>Ending<sup>*1</sup></b>	Ending animation	Default   User	Default	44
	<b>UserPict.<sup>*2</sup></b>	User Picture	From the stored files	First stored	45
CLOCK	<b>Clock Hr</b>	Hour adjustment	0 – 23 (1 – 12)	0 (0:00)	8
	<b>Clock Min</b>	Minute adjustment	00 – 59	00 (0:00)	8
	<b>24H/12H</b>	24 hours or 12 hours	12Hours   24Hours	12Hours	8,9
	<b>Auto Adj</b>	Automatic clock setting	Off   On	On	20
DISP (display)	<b>Scroll</b>	Scroll mode	Once ↔ Auto ↙ Off ↘	Once	48
	<b>Dimmer</b>	Dimmer mode	↙ Auto ↔ Off ↘ ↙ Time Set ↔ On ↘	Auto	50
	<b>From– To<sup>*3</sup></b>	Dimmer time setting	Any time – Any time	18 – 7	50
	<b>Contrast</b>	Contrast	1 – 10	5	48
	<b>LCD Type</b>	Display type	Auto ↔ Positive ↙ Negative ↘	Auto	49
	<b>Font Type</b>	Font type	1   2	1	49
	<b>Tag</b>	Tag display	Off   On	On	49
	<b>Theme</b>	Theme—Level meter	↙ Standard ↔ Meter 1 ↘ ↙ Meter 3 ↔ Meter 2 ↘	Standard	9
TUNER	<b>PTY Stnby</b>	PTY standby	See page 21.	News	17
	<b>AF-Regn'l</b>	Alternate frequency/ Regionalization reception	AF ↔ AF Reg ↙ Off <sup>*4</sup> ↘	AF	16
	<b>TA Volume</b>	Traffic announcement volume	Volume 0 — Volume 50	Volume 20	20
	<b>P-Search</b>	Program search	Off   On	Off	20

\*1 Displayed only after a downloadable file is stored in memory.

\*2 Displayed only after a downloadable file is stored in memory and while selecting “UserPict.” for “Graphics.”

\*3 Displayed only when “Dimmer” is set to “Time Set.”

\*4 Displayed only when “DAB AF” is set to “Off.”



		Indications	Selectable values		Initial settings	Page
TUNER	<b>IF Filter</b>	Intermediate frequency filter	Wide	Auto	Auto	49
	<b>DAB AF*5</b>	Alternative frequency search	Off	On	On	69
AUDIO	<b>Announce*5</b>	Announcement standby	See page 68.		Travel	66
	<b>Beep</b>	Key-touch tone	Off	On	On	49
	<b>Line In*6</b>	Line Input switch	Off	On	On	49
	<b>Telephone</b>	Telephone muting	Off	↔ Muting1 ↕ Muting2 ↕	Off	49
	<b>PowerAmp</b>	Power amplifier switch	Off	On	On	49

\*5 Displayed only when the DAB tuner is connected.

\*6 Not displayed when the current source is "LINE IN."

### To show the graphics on the display— Graphics

You can change the graphics shown on the display. These graphics appear if no operation is done for about 20 seconds (except for "ImageLink").

- All Demo: Display demonstration (animation) appears (see page 8).
- Int Demo: Display demonstration (animation) and playback source indication appears alternately (see page 8).
- UserMovie: Your edited animation appears (see pages 44 and 45).
- UserSlide: Your edited still images appears in sequence (see pages 44 and 45).
- UserPict.: One of your edited still image appears (see pages 44 and 45).
- ImageLink: To show a still image while playing back an MP3/WMA tracks (see page 24).
- Off: Cancels all graphic display above.

**Note:**

You can select "UserMovie," "UserSlide," and "UserPict." only after downloading the appropriate files in memory. (See page 40.)

### To select the source animation on the display—KeyIn CFM

When changing the source, the display shows the source animation. You can select the source animation on the display according to your preference.

- Long: A long source animation appears.
- Short: A short source animation appears.
- Off: Cancels the source animation.

### To select the scroll mode—Scroll

When a disc information is emphasized at the center of the display, it is shown entirely by scrolling if it cannot be shown at a time.

- Once: Scrolls only once.
- Auto: Repeats the scroll (in 5-second intervals).
- Off: Cancels scroll mode.

**Note:**

Even if the scroll mode is set to "Off," you can scroll the display by pressing DISP (D) for more than 1 second.

### To adjust the display contrast level —Contrast

You can adjust the display contrast level among 1 to 10.

Adjust it to make the display indications clear and legible.





## To select the display illumination pattern—LCD Type

You can select the display illumination patterns according to your preference.

- Auto: Positive pattern will be selected during the day time (depending on the “Dimmer” setting); on the other hand, negative pattern will be used during the night time (depending on the “Dimmer” setting).
- Positive: Positive (normal) pattern of the display.
- Negative: Negative pattern of the display.

## To select the font on the display—Font Type

You can change the font types used on the display. Select either “1” or “2” according to your preference.

## To turn the tag display on or off—Tag

An MP3 and WMA track can contain track information called “Tag” where its album name, performer, track title, etc. are recorded.

- On: Turns on the Tag display while playing MP3 or WMA tracks.
  - If a track does not have Tags, folder name and track name appear.
- Off: Turns off the Tag display while playing MP3 or WMA tracks. (Only the folder name and track name appear.)

### Notes:

- If you change the setting from “Off” to “On” while playing a track, the tag display will be activated when the next track starts playing.
- For MP3 tracks only: There are two versions—ID3v1 (ID3 Tag version 1) and ID3v2 (ID3 Tag version 2). When both ID3v1 and ID3v2 are recorded, ID3v2 will be shown.

## To change the FM tuner selectivity—IF Filter

In some areas, adjacent stations may interfere with each other. If this interference occurs, noise may be heard.

- Auto: When this type of interference occurs, this unit automatically increases the tuner selectivity so that interference noise will be reduced. (But the stereo effect will also be lost.)
- Wide: Subject to the interference from adjacent stations, but sound quality will not be degraded and the stereo effect will not be lost.

## To turn on/off the key-touch tone—Beep

You can deactivate the key-touch tone if you do not want it to beep each time you press a button.

- On: Activates the key-touch tone.
- Off: Deactivates the key-touch tone.

## To select the telephone muting—Telephone

This mode is used when a cellular phone system is connected. Depending on the phone system used, select either “Muting1” or “Muting2,” whichever mutes the sounds from this unit.

- Muting1: Selects this if this setting can mute the sounds when using the cellular phone.
- Muting2: Selects this if this setting can mute the sounds when using the cellular phone.
- Off: Cancels the telephone muting.

## To turn on/off the line input switch—Line In

You can switch off the line input when no external component is connected to the LINE IN plugs.

- On: You can select “LINE IN” as the playback source.
- Off: You cannot select “LINE IN” as the playback source.

## To turn on/off the power amplifier switch—PowerAmp

You can switch off the built-in amplifier and send the audio signals only to the external amplifier(s) to get clear sounds and to prevent internal heat buildup inside this unit.

- On: When not using external amplifier(s).
- Off: When using external amplifier(s).



## Selecting the dimmer mode

You can dim the display at night automatically or as you set the timer. When shipped from the factory, Auto Dimmer mode is activated.

**Note:**

*Auto Dimmer equipped with this unit may not work correctly on some vehicles, particularly on those having a control dial for dimming. In this case, select any other than "Auto."*

**1** Press and hold SEL (select) for more than 2 seconds so that one of the PSM items appears on the display. (PSM: see pages 47 and 48.)



**2** Press number button 3 to select "DISP"—Display category of the PSM settings.

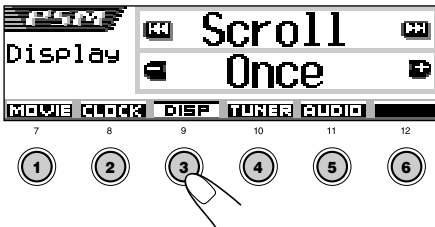

**3** Press >>> ^ or <<< v to select "Dimmer."



**4** Set the dimmer mode as you like.



- Auto: Activates Auto Dimmer. When you turn on the car head lights, the display automatically dims.
- Off: Cancels Auto Dimmer.
- On: Always dims the display.
- Time Set: Used to set the timer for the dimmer mode.

**Note:**

*Selecting "Auto" or "Time Set" may change the display pattern to the "Negative" or "Positive" pattern if "LCD Type" is set to "Auto."*

- If you select "Time Set," go to the following steps to set the timer.
- If you select any other than "Time Set," go to step 7 to finish the setting.

**5** Select "From-To" to set the timer for the dimmer mode.



**6** Set the timer.

- 1 Turn the control dial to select the start time.
- 2 Press >>> ^ once.
- 3 Turn the control dial to select the end time.

**7** Finish the setting.





# Assigning names to the sources

You can assign names to CDs (both in this unit and in the CD changer), and the external component. After assigning a name, it will appear on the display when you select the source.

Sources	Maximum number of characters
CDs*	Up to 32 characters (up to 40 discs)
External component	Up to 8 characters

\* You cannot assign a name to CD Text, MP3, and WMA discs.

## 1 Select a source you want to assign a name to.

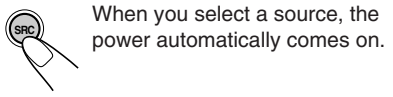

## 2 While holding DISP (D), press and hold SEL (select) for more than 2 seconds.

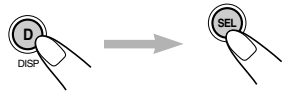

Ex.: When you select CD as the source

## 3 Select the character set you want while the first character position is flashing.

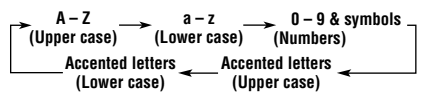
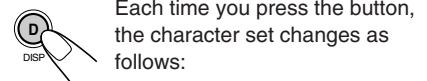

## 4 Select a character.

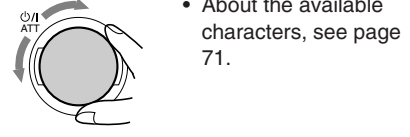

## 5 Move the cursor to the next (or previous) character position.

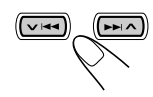

## 6 Repeat steps 3 to 5 until you finish entering the name.

## 7 Finish the procedure while the last selected character is flashing.



### To erase the entered characters

Insert spaces using the same procedure described above.

### Notes:

- When you try to assign a name to the 41st disc, "Name Full" appears on the display, and you cannot enter the text entry mode. In this case, delete unwanted names before assignment.
- When the CD changer is connected, you can assign names to CDs in the CD changer. These names can also be shown on the display if you insert the CDs in this unit.



# Changing the control panel angle

You can change the angle of the control panel to four positions.

**1** Press and hold ▲ (◀▶) until the angle adjustment screen appears.



The ▲ (up) and ▼ (down) buttons start flashing to teach you that they can be used for the next operational steps.



**2** Adjust the angle to the position you want.

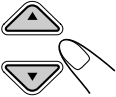

**CAUTION:**

NEVER insert your finger in between the control panel and the unit, as it may get caught or hurt.

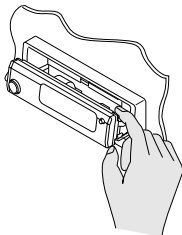

The control panel angles changes as follows:

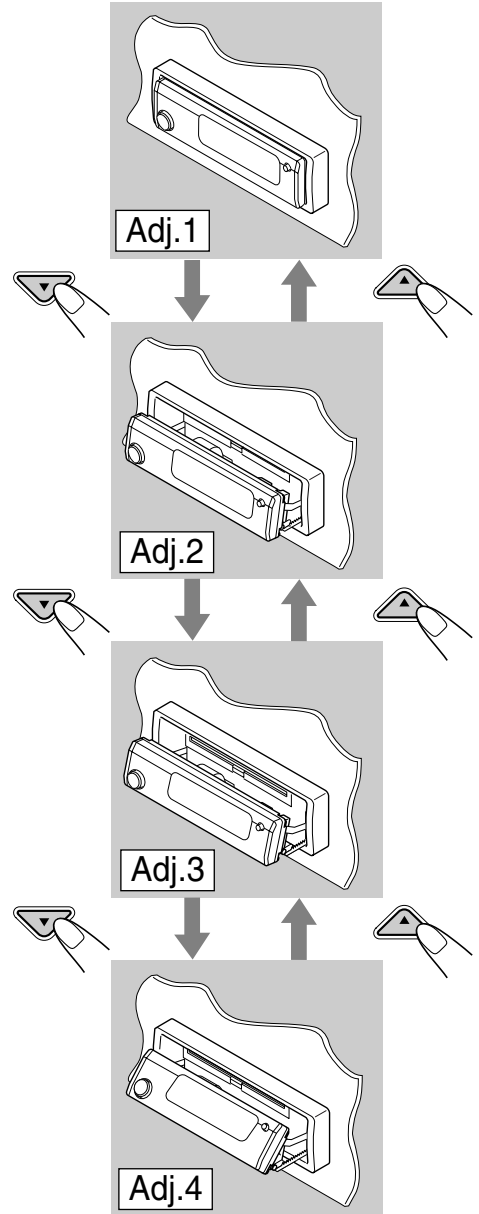

**When using the remote controller**

You can change the angle position simply by pressing ANGLE ▲ or ANGLE ▼.



## Detaching the control panel

You can detach the control panel when leaving the car.  
When detaching or attaching the control panel, be careful not to damage the connectors on the back of the control panel and on the panel holder.

### Detaching the control panel

Before detaching the control panel, be sure to turn off the power.

#### 1 Unlock the control panel.

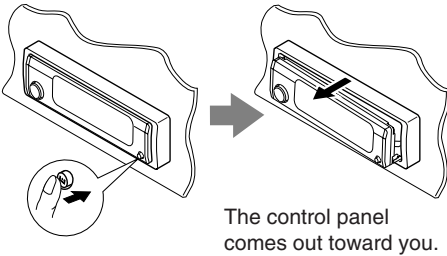

#### 2 Move the control panel to the right, then pull it out of the unit.

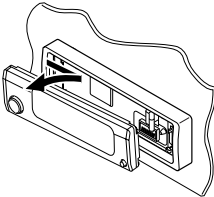

#### 3 Put the detached control panel into the provided case.

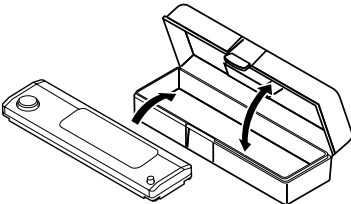

## Attaching the control panel

#### 1 Insert the left side of the control panel into the groove on the panel holder.

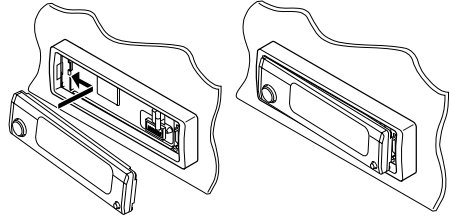

#### 2 Press the right side of the control panel to fix it to the panel holder.

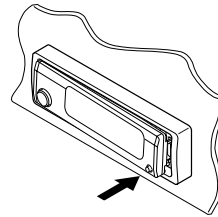

#### Note on cleaning the connectors:

If you frequently detach the control panel, the connectors will deteriorate.  
To minimize this possibility, periodically wipe the connectors with a cotton swab or cloth moistened with alcohol, being careful not to damage the connectors.

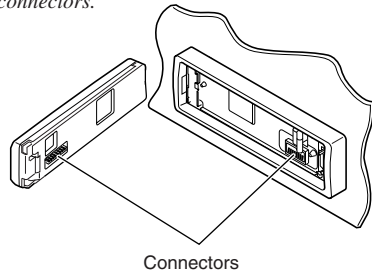



# CD CHANGER OPERATIONS

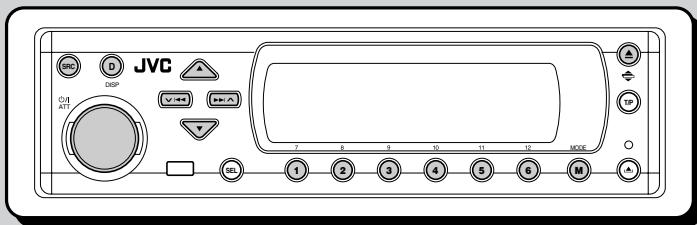

We recommend that you use the JVC MP3-compatible CD changer with your unit.

By using this CD changer, you can play back your original CD-Rs (Recordable) and CD-RWs (Rewritable) recorded either in audio CD format or in MP3 format.

- You can also connect other CH-X series CD changers (except CH-X99 and CH-X100). However, they are not compatible with MP3 discs, so you cannot play back MP3 discs.
- You cannot use the KD-MK series CD changers with this unit.

Before operating your CD changer:

- Refer also to the Instructions supplied with your CD changer.
- If no discs are in the magazine of the CD changer or the discs are inserted upside down, "No Disc" will appear on the display. If this happens, remove the magazine and set the discs correctly.
- If no magazine is loaded in the CD changer, "No Magazine" appears on the display. If this happens, insert the magazine in the CD changer.
- If "Reset 01" – "Reset 08" appears on the display, something is wrong with the connection between this unit and the CD changer. If this happens, check the connection and make sure the cords are connected firmly. Then, press the reset button of the CD changer.

### Note:

You cannot control and play any WMA disc on the CD changer.

## Playing discs

### Select the CD automatic changer (CD-CH).



Each time you press the button, the source changes as described on page 7. When you select a source, the power automatically comes on.

Playback starts from the first track of the first disc, and all tracks of all discs are played back.

- When the current disc is an audio CD or a CD Text disc:

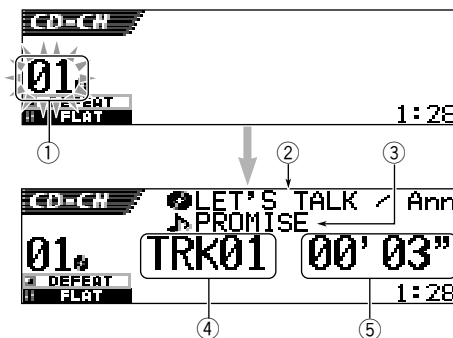

- ① Disc number
- ② Disc title/performer (if no title is recorded or assigned, "No Name" appears.)
- ③ Track title (if no title is recorded, "No Name" appears.)
- ④ Current track number
- ⑤ Elapsed playing time of the current track

• When the current disc is an MP3 disc:

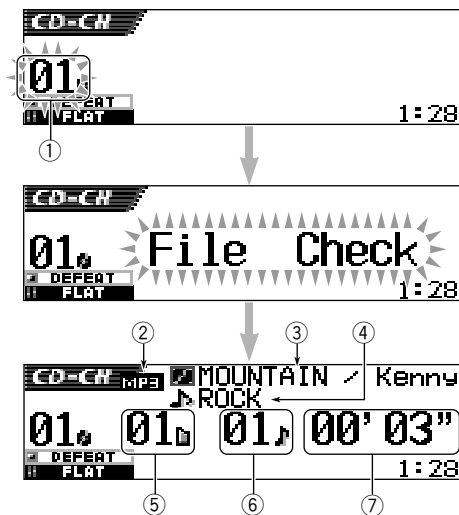

- ① Disc number
- ② Disc type—MP3
- ③ Album title/performer (or folder name when “Tag” is set to “Off”—see page 49, or when no Tag is recorded)
- ④ Track title (or track name when “Tag” is set to “Off”—see page 49, or when no Tag is recorded)
- ⑤ Current folder number
- ⑥ Current track number
- ⑦ Elapsed playing time of the current track

### To change the display pattern

By pressing DISP (D), you can change the information shown on the display.



Each time you press the button, the display patterns change.

- For details, see page 31.

### If you change the source or turn off the unit

Disc play also stops. Next time you select “CD-CH” as the source, disc play starts from where it has been stopped previously.

### To go to a particular disc directly

Press the number button corresponding to the disc number to start its playback (while the CD changer is playing).

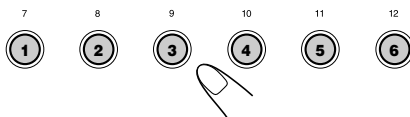

- To select a disc number from 1 – 6:  
Press 1 (7) – 6 (12) briefly.
- To select a disc number from 7 – 12:  
Press and hold 1 (7) – 6 (12) for more than 1 second.

### To fast-forward or reverse the track

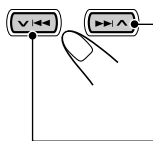

Press and hold , while playing a disc, to fast-forward the track.



Press and hold , while playing a disc, to reverse the track.

**Note:**

During this operation on an MP3 disc, you can only hear intermittent sounds. (The elapsed playing time also changes intermittently on the display.)

### To go to the next track or the previous tracks

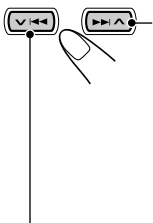

Press briefly, while playing a disc, to go ahead to the beginning of the next track. Each time you press the button consecutively, the beginning of the next tracks is located and played back.

Press briefly, while playing a disc, to go back to the beginning of the current track. Each time you press the button consecutively, the beginning of the previous tracks is located and played back.

## To go to a track quickly

This operation is only possible when using JVC MP3-compatible CD changer CH-X1500.

- 1 Press MODE (M) while playing a disc.  
“Mode” appears on the display, and the number buttons and ▲ (up)/▼ (down) buttons start flashing.



While playing an audio CD or a CD Text disc:

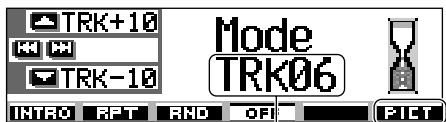

Current track number

See page 40 for this function.

While playing an MP3 disc:

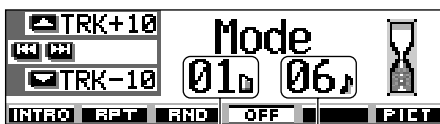

Current folder number

Current track number

- 2 Press ▲ (up) or ▼ (down), while “Mode” is still on the display.  
First time you press ▲ (up) or ▼ (down), the track skips to the nearest higher or lower track with a track number of multiple ten (ex. 10th, 20th, 30th). Then, each time you press the button, you can skip 10 tracks (see “How to go to the desired track quickly” that follows).
  - After the last track, the first track will be selected, and vice versa.
  - While playing an MP3 disc, this operation is possible only within a folder.

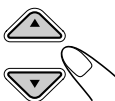

### How to go to the desired track quickly

- Ex. 1: To select track number 32 while playing track number 6

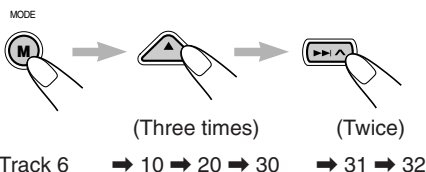

- Ex. 2: To select track number 8 while playing track number 36

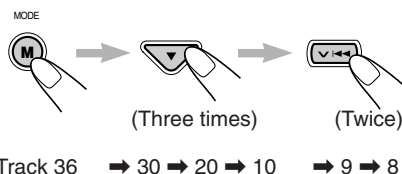



## Locating a folder on a disc

The following operations are only possible when playing an MP3 disc using a JVC MP3-compatible CD changer, CH-X1500.

### To skip to the next or previous folder (either on the same or different hierarchy levels)

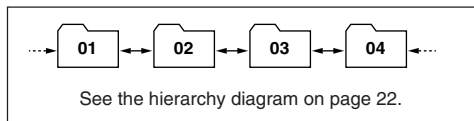

### To skip to the next or previous folder within a folder (on the same hierarchy level)

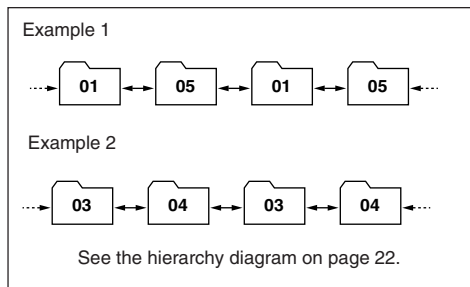

#### On the control panel:



Press ▲ (up) while playing a disc to skip to the next folder. Each time you press the button consecutively, the next folder is located and the first track in the folder starts playing.

Press ▼ (down) while playing a disc to skip back to the previous folder.

Each time you press the button consecutively, the previous folder is located and the first track in the folder starts playing.

#### ONLY on the remote controller:

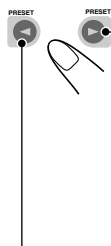

Press ► (right) while playing a disc to skip to the next folder. Each time you press the button consecutively, the next folder included within the same folder (on the same hierarchy level) is located (and the first track in the folder starts playing if recorded).

Press ◀ (left) while playing a disc to skip back to the previous folder.

Each time you press the button consecutively, the previous folder included within the same folder (on the same hierarchy level) is located (and the first track in the folder starts playing if recorded).

#### On the remote controller:

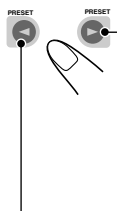

Press and hold ► (right) while playing a disc to skip to the next folder. Each time you press and hold the button consecutively, the next folder is located and the first track in the folder starts playing.

Press and hold ◀ (left) while playing a disc to skip back to the previous folder. Each time you press and hold the button consecutively, the previous folder is located and the first track in the folder starts playing.

#### Note:

If the folder does not contain any MP3 tracks, playback will not start ("No Music" appears on the display). Select another folder.

**To go back to the root directly**, press **R-D** on the remote controller. You can go back to the root from any folder.

- If tracks are recorded on the disc directly without putting them into a folder, this unit starts playing the tracks.

#### Note:

If the folder does not contain any MP3 tracks, it is skipped.



## Selecting a disc/folder/track using the name lists

### To select a disc using the disc lists

If you forget what discs are loaded in the CD changer, you can show the disc name list and select a disc in the list shown on the display.

- The display can show only six names at a time.

- While playing a disc, press and hold **▲** (up) or **▼** (down) until a disc name list appears on the display.

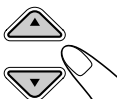

#### Note:

If a disc has a disc title (CD Text) or an assigned disc name, it will be shown on the display.

However, if the disc has not been played before, its disc number will appear.

- Press **▲** (up) or **▼** (down) to show the other disc name list, if necessary.

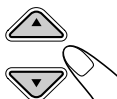

- Select the number (1 – 6) for the disc you want to play.

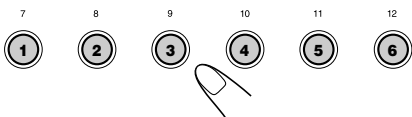

While playing an MP3 disc, you can also show the folder list(s) and track list(s) on the display, then select a folder or track.

- While playing an MP3 disc, press and hold **▲** (up) or **▼** (down) until a disc name list appears on the display.

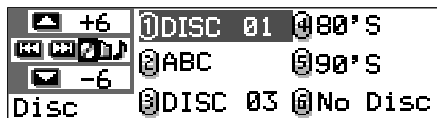
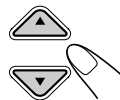

- Press **▶▶▲** or **▼◀◀** to show a folder list of the current disc or track list of the current folder.

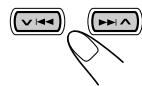

Each time you press the button, the lists on the display change as follows:



Ex. When folder list is selected

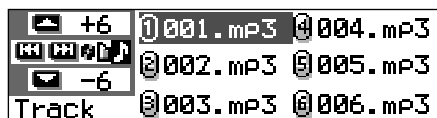

Ex. When track list is selected

#### Note:

The display can show only six names at a time. You can show the other names on the next lists by pressing **▲** (up) or **▼** (down).

- Press the number button for the disc, folder or track you want to play.

## Selecting playback modes

### To play back tracks at random (Random Play)

You can play back tracks on a disc, on all loaded discs (or in a folder for MP3 discs) at random.

- 1 Press MODE (M) while playing a disc.

“Mode” appears on the display, then the number buttons and the ▲ (up)/▼ (down) buttons start flashing.



While playing an audio CD or a CD Text disc:

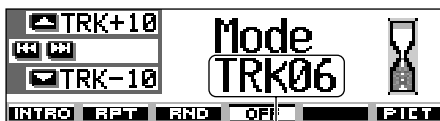

Current track number

While playing an MP3 disc:

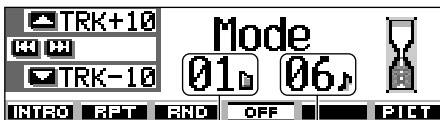

Current folder number

Current track number

- 2 Press number button 3, while “Mode” is still on the display.

Each time you press the button, random play mode changes as follows:

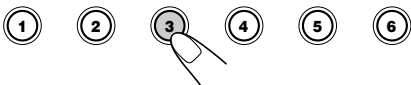

For audio CD and CD Text discs:



For MP3 discs:

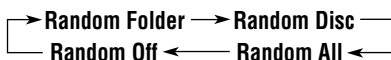

Mode	Plays randomly
<b>Random Folder*</b> :	All tracks of the current folder, then moves to the next folder and so on. <ul style="list-style-type: none"> <li>While playing, <b>RND</b> lights up on the display.</li> </ul>
<b>Random Disc</b> :	All tracks on the disc. <ul style="list-style-type: none"> <li>While playing, <b>RND</b> lights up on the display.</li> </ul>
<b>Random All</b> :	All tracks of all discs inserted in the magazine. <ul style="list-style-type: none"> <li>While playing, <b>ALL RND</b> lights up on the display.</li> </ul>

\* “Random Folder” can be used for MP3 discs only.

**To cancel Random Play**, select “Random Off” by pressing number button 3 repeatedly or press number button 4 in step 2.



### To play back tracks repeatedly (Repeat Play)

You can play back a track, a disc (or a folder for MP3 discs) repeatedly.

- 1 Press MODE (M) while playing a disc.  
“Mode” appears on the display, then the number buttons and the ▲ (up)/▼ (down) buttons start flashing.



- 2 Press number button 2, while “Mode” is still on the display.  
Each time you press the button, repeat play mode changes as follows:

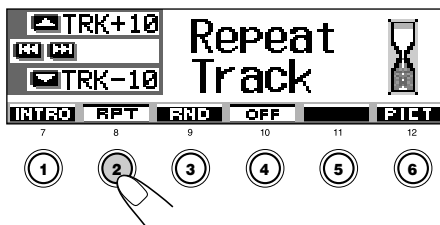

For audio CD and CD Text discs:



For MP3 discs:

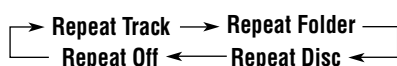

Mode	Plays repeatedly
<b>Repeat Track</b> :	Current (or specified) track. • While playing, <b>RPT</b> lights up on the display.
<b>Repeat Folder*</b> :	All tracks of the current (or specified) folder. • While playing, <b>RPT</b> lights up on the display.
<b>Repeat Disc</b> :	All tracks of the current (or specified) disc. • While playing, <b>RPT</b> lights up on the display.

\* “Repeat Folder” can be used for MP3 discs only.

**To cancel Repeat Play**, select “Repeat Off” by pressing number button 2 repeatedly or press number button 4 in step 2.

### To play back only intros (Intro Scan)

You can play back the first 15 seconds of each track sequentially.

- 1 Press MODE (M) while playing a disc.  
“Mode” appears on the display, then the number buttons and the ▲ (up)/▼ (down) buttons start flashing.



- 2 Press number button 1, while “Mode” is still on the display.  
Each time you press the button, intro scan mode changes as follows:

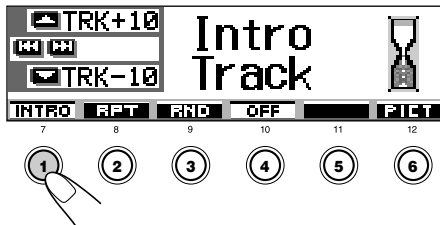

For audio CD and CD Text discs:



For MP3 discs:

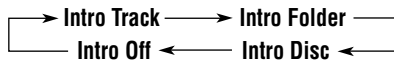

Mode	Plays the beginnings of
<b>Intro Track</b> :	All tracks of the disc. • While playing, <b>INT</b> lights up on the display.
<b>Intro Folder*</b> :	First tracks of all folders of the current disc. • While playing, <b>INT</b> lights up on the display.
<b>Intro Disc</b> :	First tracks of all inserted discs. • While playing, <b>INT</b> lights up on the display.

\* “Intro Folder” can be used for MP3 discs only.

**To cancel Intro Scan**, select “Intro Off” by pressing number button 1 repeatedly or press number button 4 in step 2.

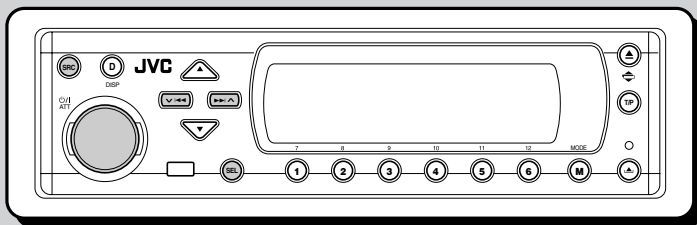

## Playing an external component

You can connect an external components to the LINE IN plugs on the rear.

- If you cannot select “LINE IN” as the source, change the “Line In” setting to “On.” (See page 49.)

### 1 Select the external component (LINE IN).



Each time you press the button, the source changes as described on page 7. When you select a source, the power automatically comes on.

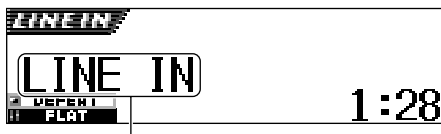

If you have assigned a different name to the external component, it will appear.

### 2 Turn on the connected component and start playing the source.

### 3 Adjust the volume.

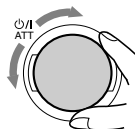

### 4 Select the DSP mode and sound mode as you want.

- For the DSP modes, see page 32.
- For the sound (iEQ) modes, see page 35.

**Note:**

When the source is “LINE IN,” the DISP (D) button will not work.

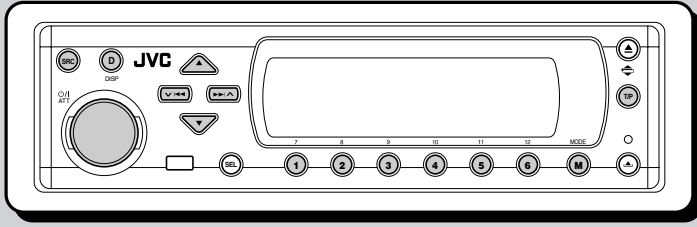

We recommend that you use DAB (Digital Audio Broadcasting) tuner KT-DB1500 or KT-DB1000 with your unit.

If you have another DAB tuner, consult your JVC IN-CAR ENTERTAINMENT dealer.

- Refer also to the Instructions supplied with your DAB tuner.

## What is DAB system?

DAB is one of the digital radio broadcasting systems available today. It can deliver CD quality sound without any annoying interference and signal distortion. Furthermore, it can carry text, pictures, and data.

In contrast to FM broadcast, where each programme is transmitted on its own frequency, DAB combines several programmes (called “services”) to form one “ensemble.”

In addition, each “service”—called “primary service”—can also be divided into its components (called “secondary service”).

With the DAB tuner connected with this unit, you can enjoy these DAB services.

## Tuning in to an ensemble and one of the services

A typical ensemble has 6 or more programmes (services) broadcast at the same time. After tuning in to an ensemble, you can select a service you want to listen to.

### 1 Select the DAB tuner.



Each time you press the button, the source changes as described on page 7. When you select a source, the power automatically comes on.

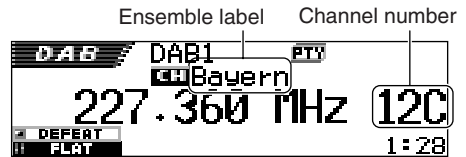

Last received ensemble (service) of the selected band is tuned in.

### 2 Select the DAB band (DAB1, DAB2, or DAB3).



1 Press and hold SRC for more than 1 second. The band indication on the display starts flashing.

2 Within about 5 seconds (while the band indication is flashing), press SRC again. Each time you press the button, the band changes.

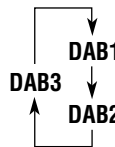

#### Note:

This receiver has three DAB bands (DAB1, DAB2, DAB3). You can use any of them to tune in to an ensemble.

### 3 Start searching for an ensemble.

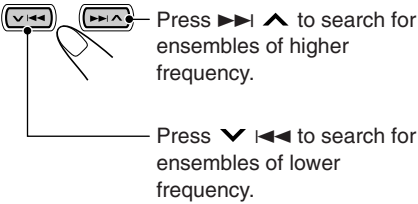

When an ensemble is received, searching stops.

To stop searching before an ensemble is received, press the same button you have pressed for searching.

### 4 Select a service (either primary or secondary) you want to listen to.

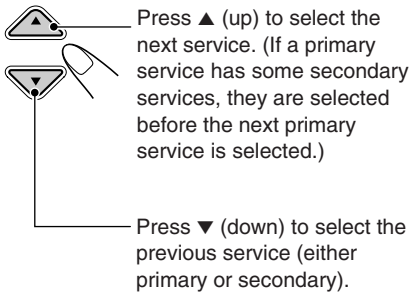

### To tune in to a particular ensemble without searching

- 1 Press SRC repeatedly to select DAB tuner as the source.
- 2 Press and hold SRC for more than 1 second.
- 3 Press SRC repeatedly to select the DAB band (DAB1, DAB2, or DAB3).
- 4 Press and hold >>> ▲ or ▼ <<< for more than one second.
- 5 Press >>> ▲ or ▼ <<< repeatedly until the ensemble you want is reached.
  - If you hold down the button, the frequency keeps changing until you release the button.
- 6 Press ▲ (up) or ▼ (down) to select a service (either primary or secondary) you want to listen to.

### When noises generated while running interfere with your listening

While driving, surrounding sounds will interfere with your listening. Especially the low level sounds will be hard to listen.

If this happens, you can reinforce the low level sounds to improve your listening.

For this purpose, some service provides Dynamic Range Control signals together with their regular program signals.

- 1 Press MODE (M) while listening to a DAB service.

“Mode” appears on the display, and the number buttons start flashing.

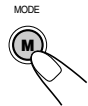

- 2 Press number button 1 repeatedly to activate the DRC function while “Mode” is still on the display.

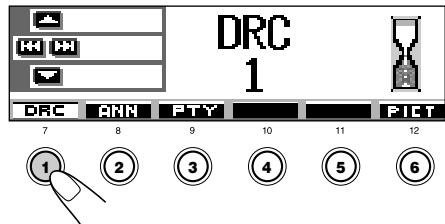

Each time you press the button, the DRC function will be set as follows:



As the number increases, the DRC effect level also increases.

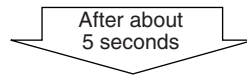

The display returns to the source indication screen.



DRC indicator appears

- The DRC indicator will be highlighted (DRC) only when the unit received DRC signals from the tuned service.

To cancel the DRC effect, select “DRC Off.”

## Storing DAB services in memory

You can preset up to 6 DAB services in each DAB band (DAB1, DAB2, and DAB3) manually.

### 1 Select the DAB tuner.



Each time you press the button, the source changes as described on page 7. When you select a source, the power automatically comes on.

### 2 Select the DAB band (DAB1, DAB2, or DAB3).



1 Press and hold SRC for more than 1 second.

The band indication on the display starts flashing.

2 Within about 5 seconds (while the band indication is flashing), press SRC again. Each time you press the button, the band changes.

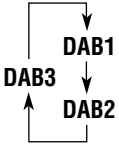

### 3 Tune in to an ensemble you want.

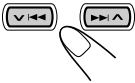

### 4 Select a service of the ensemble you want to listen to.



Press ▲ (up) to select the next service.



Press ▼ (down) to select the previous service.

### 5 Press and hold the number button (in this example, 1) you want to store the selected service into for more than 2 seconds.



The display pattern automatically changes to the initial display pattern and the preset number flashes (then the previous display pattern resumes).

### 6 Repeat the above procedure to store other DAB services into other preset numbers.

#### Notes:

- You can only preset primary DAB services. If you store a secondary service, its primary service will be stored instead.
- A previously preset DAB service is erased when a new DAB service is stored in the same preset number.

## Tuning in to a preset DAB service

You can easily tune in to a preset DAB service. Remember that you must store services first. If you have not stored them yet, “Storing DAB services in memory.”

### 1 Select the DAB tuner.



Each time you press the button, the source changes as described on page 7. When you select a source, the power automatically comes on.



## 2 Select the DAB band (DAB1, DAB2, or DAB3).

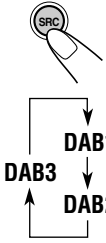

- 1 Press and hold SRC for more than 1 second. The band indication on the display starts flashing.
- 2 Within about 5 seconds (while the band indication is flashing), press SRC again. Each time you press the button, the band changes.

## 3 Select the number (1 – 6) for the preset DAB service (primary) you want.

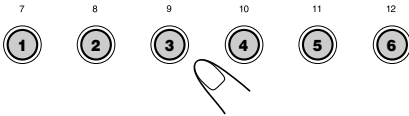

### Note:

If the selected primary service has some secondary services, pressing the same number button repeatedly will tune in to the secondary services.

## Selecting a preset service using the preset service list

If you forget what services are stored in what preset number, you can check the preset service list, then select your desired service on the list.

## 1 Select the DAB tuner.



Each time you press the button, the source changes as described on page 7. When you select a source, the power automatically comes on.

## 2 Select the DAB band (DAB1, DAB2, or DAB3).



- 1 Press and hold SRC for more than 1 second. The band indication on the display starts flashing.
- 2 Within about 5 seconds (while the band indication is flashing), press SRC again. Each time you press the button, the band changes.

## 3 Press and hold ▲ (up) or ▼ (down) until the preset ensemble (primary service) list for the current band (DAB1, DAB2, or DAB3) appears on the display.

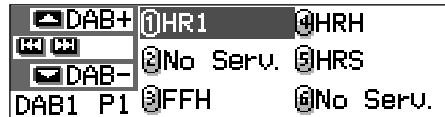
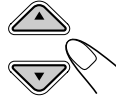

### Note:

You can show the other DAB band preset ensemble (primary service) lists (DAB1, DAB2, or DAB3) by pressing ▲ (up) or ▼ (down).

## 4 Select the number (1 – 6) for a service you want.

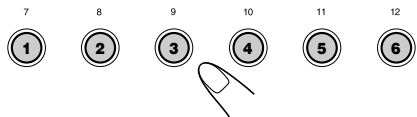

## What you can do more with DAB

With the DAB tuner connected, you can use the following convenient functions.

- Road Traffic Flash Standby Reception
- Standby Reception of 9 types of Announcement signals
- PTY Standby Reception
- PTY search
- Tracing the same program (service) automatically while driving where the same DAB ensemble is not received

### Road Traffic Flash Standby Reception



Press T/P briefly to activate Road Traffic Flash Standby Reception.

Each time you press the button, Road Traffic Flash Standby Reception turns on and off.

- When this function is turned on, the TP indicator lights up or flashes (as follows).



TP indicator appears (either lights up or flashes)

- **If you press the button while listening to a service supporting Road Traffic Flash signal**, the TP indicator lights up. This receiver now stands by for the Road Traffic Flash signal reception.
- **If you press the button while listening to a service NOT supporting Road Traffic Flash signal**, the TP indicator flashes. In this case, Road Traffic Flash Standby Reception does not work.
  - If an FM RDS station supporting TA signal is tuned in by the built-in tuner. This receiver stands by for the TA signal reception and the TP indicator lights up.

- **If you press the button while listening to any other source than AM**

- The TP indicator comes to light up when a service supporting Road Traffic Flash signal (or an FM RDS station supporting TA signal) is tuned in by the built-in tuner. This receiver now stands by for the Road Traffic Flash signal (or TA signal) reception.
- The TP indicator keeps flashing when a service supporting Road Traffic Flash signal (or an FM RDS station supporting TA signal) is NOT tuned in by the built-in tuner. In this case, this receiver cannot stand by for Road Traffic Flash signal (or TA signal) reception.

### How Road Traffic Flash Standby Reception works:

If a Road Traffic Flash (or Traffic Announcement) starts broadcasting while the Road Traffic Flash Standby Reception is activated, “Traffic Flash” appears and the unit tunes into the service (or FM RDS station) broadcasting Road Traffic Flash (or Traffic Announcement). The volume increases to the preset TA volume level and the Road Traffic Flash (or Traffic Announcement) can be heard.

### Using Announcement Standby Reception

Announcement Standby Reception allows the unit to switch temporarily to your favorite service (Announcement type).

### To select your favorite announcement type for Announcement Standby Reception

When shipped from factory, Announcement Standby Reception has been set to work for searching for “Travel” services.

You can select your favorite announcement type for Announcement Standby Reception.

- If you do not want to change the announcement type (from “Travel” to another one), go to page 68.

**1** Press and hold SEL (select) for more than 2 seconds so that one of the PSM items appears on the display. (PSM: see pages 47 and 48.)



**2** Press number button 4 to select “TUNER”—Tuner category of the PSM settings.

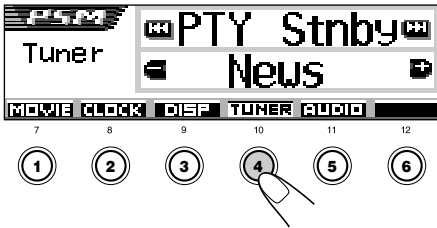

The “PTY Stnby” (standby) setting screen appears on the display.

**3** Select “Announce” (announcement).



**4** Select one of the 9 announcement types. (See page 68.)

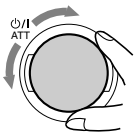

Selected announcement type appears on the display and is stored into memory.

**5** Finish the setting.



## To activate Announcement Standby Reception

**1** Press MODE (M) while listening to a DAB service. “Mode” appears on the display, and the number buttons start flashing.



**2** Press number button 2 repeatedly to activate Announcement Standby Reception while “Mode” is still on the display. Each time you press the button, Announcement Standby Reception turns on and off alternately.



See page 40 for this function.

Ex.: When the currently selected announcement type for Announcement Standby Reception is “Travel”

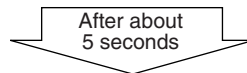

The display returns to the source indication screen.



ANN indicator appears (either lights up or flashes)

The ANN (announcement) indicator either lights up or flashes.

- If the ANN indicator lights up, Announcement Standby Reception is activated. If a service starts broadcasting a programme of the selected announcement type, this unit automatically tunes in to the service.
- If the ANN indicator flashes, Announcement Standby Reception is not yet activated since the service being received does not provide the signals used for Announcement Standby Reception.

To activate Announcement Standby Reception, you need to tune in to another service providing these signals. Press ►►| ▲ or ▼ |◄◄ to search for such a service.

When a service providing these signals is tuned in, the ANN indicator stops flashing and remains lit. Now Announcement Standby Reception is activated.

**Note:**

*After turning on Announcement Standby Reception, you can change the source without canceling Announcement Standby Reception. In this case, the ANN indicator stops flashing if it was. If a service starts broadcasting the selected announcement type, this unit automatically changes the source and tunes in to the service.*

## How Announcement Standby Reception works:

If a service of the selected Announcement type starts broadcasting while the Announcement Standby Reception is activated, selected announcement type appears and the unit tunes into the service.

### Announcement type

Travel:	Programmes about travel destinations, package tours, and travel ideas and opportunities
Warning:	Warnings about earthquakes, tsunamis, etc.
News:	News
Weather:	Weather information
Event:	Information about events, concerts, etc.
Special:	Special programmes expanding on current news or affairs
Rad Inf:	Radio information
Sports:	Sport events
Finance:	Reports on commerce, trading, the Stock Market, etc.

## Using PTY Standby Reception

PTY Standby Reception allows the unit to switch temporarily to your favorite programme (PTY: Programme Type) from any source except AM stations

- Operations are exactly the same as explained on pages 17 and 18 for FM RDS stations. You cannot use PTY Standby Reception separately for the DAB tuner and for the FM tuner.
- PTY Standby Reception works for the DAB tuner only using a Dynamic PTY, but not a Static PTY.

**To select your favorite PTY code for PTY Standby Reception**, see page 17.

**To set PTY Standby Reception**, see pages 17 and 18.

- You can set PTY Standby Reception when the source is either “FM” or “DAB.”

## Searching your favorite service

You can search any one of the PTY codes (either Dynamic or Static PTY).

In addition, you can store your 6 favorite programme types in the number buttons (see page 18).

- Operations are exactly the same as explained on pages 18 and 19 for FM RDS stations. However, you cannot store PTY codes in the number buttons separately for the DAB tuner and for the FM tuner.

**To store your favorite programme (service) type**, see pages 18 and 19.

**To search your favorite programme (service) type**, see page 19.

- Search will be performed on the DAB tuner only.

## Tracing the same program automatically (Alternative Reception)

You can keep listening to the same program.

- **While receiving a DAB service:**  
When driving in an area where a service cannot be received, this unit automatically tunes in to another ensemble or FM RDS station, broadcasting the same program.
- **While receiving an FM RDS station:**  
When driving in an area where a DAB service is broadcasting the same program as the FM RDS station is broadcasting, this unit automatically tunes in to the DAB service.

## To use Alternative Reception

When shipped from the factory, Alternative Reception is activated.

- See also “Changing the general settings (PSM)” on page 46.

- 1 Press and hold SEL (select) for more than 2 seconds so that one of the PSM items appears on the display.
- 2 Press number button 4 to select “TUNER”—Tuner category of the PSM settings.
- 3 Press ►►| ▲ or ▼ |◄◄ to select “DAB AF” (alternative frequency).
- 4 Turn the control dial to select the desired mode.
  - On: Traces the program among DAB services and FM RDS stations—Alternative Reception. The AF indicator lights up on the display (see page 15).
  - Off: Alternative Reception is deactivated.
- 5 Press SEL (select) to finish the setting.

### Note:

*When Alternative Reception (for DAB services) is activated, Network-Tracking Reception (for RDS stations: see page 15) is also activated automatically. On the other hand, Network-Tracking Reception cannot be deactivated without deactivating Alternative Reception.*

# Changing the display pattern

By pressing DISP (D), you can change the information shown on the display.

Each time you press the button, the display patterns change as follows:



- Initial display pattern:

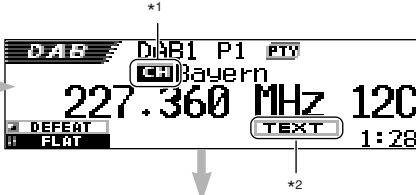

\*1 Ensemble label (primary service) indicator: The different indicator (**2nd**) will be displayed when the secondary service is selected.

- Ensemble label (name) is emphasized



\*2 TEXT indicator: implies the current service received is providing DLS (Dynamic Label Segment—DAB radio text information).

\*3 Each service can have several PTY codes. If a service have several PTY codes, they will be shown in turn.

- Service label (name) is emphasized

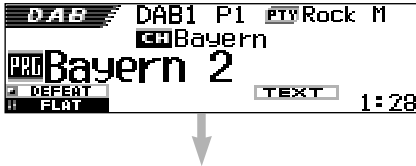

- Dynamic Label Segment (DLS) is display





## Sound modes (preset frequency level settings)

The list below shows the preset frequency level settings for each sound mode.

- You can adjust the preset sound modes temporarily. However, your temporary adjustments will be reset when you select another sound mode.

Sound Mode	Preset equalizing values						
	60 Hz	150 Hz	400 Hz	1 kHz	2.4 kHz	6 kHz	12 kHz
Flat	00	00	00	00	00	00	00
Hard Rock	+03	+03	+01	00	00	+02	+01
R & B	+03	+02	+02	00	+01	+01	+03
Pop	00	+02	00	00	+01	+01	+02
Jazz	+03	+02	+01	+01	+01	+03	+02
DanceMusic	+04	+02	00	-02	-01	+01	+01
Country	+02	+01	00	00	00	+01	+02
Reggae	+03	00	00	+01	+02	+02	+03
Classic	+02	+03	+01	00	00	+02	00
User 1	00	00	00	00	00	00	00
User 2	00	00	00	00	00	00	00
User 3	00	00	00	00	00	00	00

## Available characters

In addition to the alphabets (A – Z, a – z), you can use the following characters to assign names to CDs, and external component. (See page 51.)

- These characters can be also used to show other information such as disc title/performer, RDS, and DAB on the display.

### Accented letters

Upper case

Á	À	Â	Ä	Ã
Å	Æ	Œ	Č	Ć
Ç	É	È	Ê	Ë
Ğ	Í	Ì	Î	Ï
Ñ	Ó	Ò	Ô	Ö
Õ	Ø	Ř	Ŕ	Š
Ś	Ş	Ú	Ù	Û
Ü	Ý	Ž	Ž	ß
Ɔ	Ɔ	Ɔ	Ɔ	Ɔ
ı	u	ø	space	

Lower case

á	à	â	ä	ã
å	æ	œ	č	ć
ç	é	è	ê	ë
ğ	í	ì	î	ï
ñ	ñ	ñ	ñ	ó
ò	ô	ö	õ	ø
ő	ř	ŕ	š	ś
ş	ú	ù	û	ü
ý	w	y	y	ž
ž	ÿ	þ	ŋ	đ
ł	l	ı	ij	space

### Numbers and symbols

0	1	2	3	4
5	6	7	8	9
!	"	#	\$	%
&	'	(	)	*
+	,	-	.	/
:	;	<	=	>
?	@	_	`	i
¿	£	€	α	space



# TROUBLESHOOTING

What appears to be trouble is not always serious. Check the following points before calling a service center.

	Symptoms	Causes	Remedies
General Playback	<ul style="list-style-type: none"> <li>Sound is sometimes interrupted.</li> </ul>	You are driving on rough roads.	Stop playback while driving on rough roads.
		Disc is scratched.	Change the disc.
		Connections are incorrect.	Check the cords and connections.
	<ul style="list-style-type: none"> <li>Sound cannot be heard from the speakers.</li> </ul>	The "PowerAmp" setting is set to "Off."	Set it to "On" (see page 49).
		Connections are incorrect.	Check the cords and connections.
	<ul style="list-style-type: none"> <li>CD-R/CD-RW cannot be played back.</li> <li>Tracks on the CD-R/CD-RW cannot be skipped.</li> </ul>	Disc is inserted upside down.	Insert the disc correctly.
		CD-R/CD-RW is not finalized.	<ul style="list-style-type: none"> <li>Insert a finalized CD-R/CD-RW.</li> <li>Finalize the CD-R/CD-RW with the component which you used for recording.</li> </ul>
	<ul style="list-style-type: none"> <li>Disc cannot be ejected.</li> </ul>	Disc is locked.	Unlock the disc (see page 30.)
	<ul style="list-style-type: none"> <li>Disc cannot be recognized ("No Disc," "Loading Error," or "Eject Error" flashes).</li> </ul>	The CD player may function incorrectly.	While holding <b>⏻</b> ATT, press <b>▲</b> for more than 2 seconds to eject the disc.
	<ul style="list-style-type: none"> <li>This unit does not work at all.</li> </ul>	The built-in microcomputer may have functioned incorrectly due to noise, etc.	Press the reset button on the control panel using a ball-point pen (see page 2).
<ul style="list-style-type: none"> <li>When "Reset P00" to "Reset P44" appears on the display.</li> </ul>	There is something is blocking the control panel movement.	Press the reset button on the control panel using a ball-point pen (see page 2). If the reset button does not work. Check the installation. (Ex. you have used a screws which are longer than specified.)	
<ul style="list-style-type: none"> <li><b>INPUT OVER</b> (INPUT OVER) indicator appears on the display.</li> </ul>	Input level through the external component (LINE IN) is too high.	Adjust the output level on the external component.	
FM/AM	<ul style="list-style-type: none"> <li>"Panel Connect Error" appears on the display.</li> </ul>	The control panel is not attached correctly and firmly.	Remove the control panel, wipe the connectors, then attach it again (see page 53).
	<ul style="list-style-type: none"> <li>SSM automatic preset does not work.</li> </ul>	Signals are too weak.	Store stations manually.
	<ul style="list-style-type: none"> <li>Static noise while listening to the radio.</li> </ul>	The antenna is not connected firmly.	Connect the antenna firmly.





Symptoms	Causes	Remedies	
<ul style="list-style-type: none"> <li>Download does not seem to finish.</li> </ul>	You are trying to download an animation of many frames.	This is normal (see page 40).	Graphics
<ul style="list-style-type: none"> <li>Animation does not move.</li> </ul>	Temperature in the car compartment is very low— (LOW TEMP.) indicator appears.	Wait until the operating temperature resumes—until  (LOW TEMP.) indicator goes off.	
<ul style="list-style-type: none"> <li>“Movie” category settings in the PSM do not take effect.</li> </ul>			
<ul style="list-style-type: none"> <li>“No Disc” flashes on the display .</li> </ul>	No disc in the magazine.	Insert a disc.	CD Changer
<ul style="list-style-type: none"> <li>“Reset 08” flashes on the display .</li> </ul>	This unit is not connected to a CD changer correctly.	Connect this unit and the CD changer correctly and press the reset button of the CD changer.	
<ul style="list-style-type: none"> <li>“Reset 01” – “Reset 07” flashes on the display.</li> </ul>	_____	Press the reset button of the CD changer.	
<ul style="list-style-type: none"> <li>Disc cannot be played back.</li> </ul>	MP3/WMA tracks do not have the extension code—mp3 or wma in their file names.	Add the extension code—mp3 or wma to their file names.	MP3/WMA Playback
	MP3/WMA tracks are not recorded in the format compliant with ISO 9660 Level 1, ISO 9660 Level 2, Romeo, or Joliet.	Change the disc. (Record MP3/WMA tracks using a compliant application.)	
<ul style="list-style-type: none"> <li>“Unplayable File” appears and tracks skip.</li> </ul>	Tracks are not encoded in an appropriate format.	Insert a disc that contains tracks encoded in an appropriate format.	
	WMA tracks are copy-protected.	This is normal. Copy-protected tracks cannot be played back.	
<ul style="list-style-type: none"> <li>Noise is generated.</li> </ul>	The track played back is not an MP3/WMA file (although it has the extension code—mp3 or wma).	Skip to another track or change the disc. (Do not add the extension code—mp3 or wma to non-MP3 or WMA files.)	
<ul style="list-style-type: none"> <li>Elapsed playing time is not correct.</li> </ul>	This sometimes occurs during play. This is caused by how the tracks are recorded on the disc.	Select another folder.	
<ul style="list-style-type: none"> <li>“No Files” appears on the display for a while, then the disc ejects.</li> </ul>	The current MP3/WMA disc does not contain any MP3/WMA tracks.	Insert a disc that contains MP3/WMA tracks.	
<ul style="list-style-type: none"> <li>“No Music” appears on the display.</li> </ul>	No MP3/WMA tracks are included in the folder.	Select another folder including MP3/WMA tracks.	
	Only <jml> and/or <jma> files are recorded on the disc.	Insert a disc including MP3 or WMA tracks.	
<ul style="list-style-type: none"> <li>Correct characters are not displayed. (e.g. album name)</li> </ul>	This unit can only display alphabets (capital: A–Z, small: a–z), numbers, and a limited number of symbols.	_____	



## Handling discs

This unit has been designed to reproduce CDs, CD-Rs (Recordable), CD-RWs (Rewritable), and CD Texts.

- This unit is also compatible with MP3 and WMA discs.

### How to handle discs

**When removing a disc from its case**, press down the center holder of the case and lift the disc out, holding it by the edges.

Center holder



- Always hold the disc by the edges. Do not touch its recording surface.

**When storing a disc into its case**, gently insert the disc around the center holder (with the printed surface facing up).

- Make sure to store discs into the cases after use.

### To keep discs clean

A dirty disc may not play correctly. If a disc does become dirty, wipe it with a soft cloth in a straight line from center to edge.



### To play new discs

New discs may have some rough spots around the inner and outer edges. If such a disc is used, this unit may reject the disc.

To remove these rough spots, rub the edges with a pencil or ball-point pen, etc.



### Moisture condensation

Moisture may condense on the lens inside the CD player in the following cases:

- After starting the heater in the car.
- If it becomes very humid inside the car.

Should this occur, the CD player may malfunction. In this case, eject the disc and leave the unit turned on for a few hours until the moisture evaporates.

### When playing a CD-R or CD-RW

Before playing back CD-Rs or CD-RWs, read their instructions or cautions carefully.

- Use only “finalized” CD-Rs or CD-RWs.
- Some CD-Rs or CD-RWs may not play back on this unit because of their disc characteristics, and for the following reasons:
  - Discs are dirty or scratched.
  - Moisture condensation on the lens inside the unit.
  - The pickup lens inside the unit is dirty.
- CD-RWs may require a longer readout time since the reflectance of CD-RWs is lower than that of regular CDs.
- CD-Rs or CD-RWs are susceptible to high temperatures or high humidity, so do not leave them inside your car.
- Do not use following CD-Rs or CD-RWs:
  - Discs with stickers, labels, or protective seal stuck to the surface.
  - Discs on which labels can be directly printed by an ink jet printer.

Using these discs under high temperatures or high humidity may cause malfunctions or damage to discs. For example,

- Stickers or labels may shrink and warp a disc.
- Stickers or labels may peel off so discs cannot be ejected.
- Print on discs may get sticky.

Read instructions or cautions about labels and printable discs carefully.

#### CAUTIONS:

- Do not insert 8 cm discs (single CDs) into the loading slot. (Such discs cannot be ejected.)
- Do not insert any disc of unusual shape—like a heart or flower; otherwise, it will cause a malfunction.
- Do not expose discs to direct sunlight or any heat source or place them in a place subject to high temperature and humidity. Do not leave them in a car.
- Do not use any solvent (for example, conventional record cleaner, spray, thinner, benzine, etc.) to clean discs.

Warped disc



Sticker



Sticker residue

Disc



Stick-on label

## AUDIO AMPLIFIER SECTION

Maximum Power Output:

Front: 50 W per channel

Rear: 50 W per channel

Continuous Power Output (RMS):

Front: 19 W per channel into 4  $\Omega$ , 40 Hz to 20 000 Hz at no more than 0.8% total harmonic distortion.

Rear: 19 W per channel into 4  $\Omega$ , 40 Hz to 20 000 Hz at no more than 0.8% total harmonic distortion.

Load Impedance: 4  $\Omega$  (4  $\Omega$  to 8  $\Omega$  allowance)

Equalizer Control Range:

Frequencies: 60 Hz, 150 Hz, 400 Hz, 1 kHz, 2.4 kHz, 6 kHz, 12 kHz

Level:  $\pm 10$  dB

Frequency Response: 40 Hz to 20 000 Hz

Signal-to-Noise Ratio: 70 dB

Line-In Level/Impedance:

LINE IN: 1.5 V/20 k $\Omega$  load

Line-Out Level/Impedance:

4.0 V/20 k $\Omega$  load (full scale)

Output Impedance: 1 k $\Omega$

## TUNER SECTION

Frequency Range:

FM: 87.5 MHz to 108.0 MHz

AM: (MW) 522 kHz to 1 620 kHz

(LW) 144 kHz to 279 kHz

### **[FM Tuner]**

Usable Sensitivity: 11.3 dBf (1.0  $\mu$ V/75  $\Omega$ )

50 dB Quieting Sensitivity: 16.3 dBf (1.8  $\mu$ V/75  $\Omega$ )

Alternate Channel Selectivity (400 kHz): 65 dB

Frequency Response: 40 Hz to 15 000 Hz

Stereo Separation: 30 dB

Capture Ratio: 1.5 dB

### **[MW Tuner]**

Sensitivity: 20  $\mu$ V

Selectivity: 35 dB

### **[LW Tuner]**

Sensitivity: 50  $\mu$ V

## CD PLAYER SECTION

Type: Compact disc player

Signal Detection System: Non-contact optical pickup (semiconductor laser)

Number of channels: 2 channels (stereo)

Frequency Response: 5 Hz to 20 000 Hz

Dynamic Range: 98 dB

Signal-to-Noise Ratio: 102 dB

Wow and Flutter: Less than measurable limit

MP3 (MPEG Audio Layer 3)

Max. Bit rate: 320 Kbps

WMA (Windows Media® Audio)

Max. Bit rate: 192 Kbps

## GENERAL

Power Requirement:

Operating Voltage: DC 14.4 V

(11 V to 16 V allowance)

Grounding System: Negative ground

Allowable Operating Temperature:

0°C to +40°C

Dimensions (W  $\times$  H  $\times$  D):

Installation Size:

182 mm  $\times$  52 mm  $\times$  161 mm

Panel Size:

188 mm  $\times$  58 mm  $\times$  17 mm

Mass: 1.8 kg (excluding accessories)

*Design and specifications are subject to change without notice.*

**Having TROUBLE with operation?**

**Please reset your unit**

Refer to page of How to reset your unit

**Haben Sie PROBLEME mit dem Betrieb?**

**Bitte setzen Sie Ihr Gerät zurück**

Siehe Seite Zurücksetzen des Geräts

**Vous avez des PROBLÈMES de fonctionnement?**

**Réinitialisez votre appareil**

Référez-vous à la page intitulée Comment réinitialiser votre appareil

**Hebt u PROBLEMEN met de bediening?**

**Stel het apparaat terug**

Zie de pagina met de paragraaf Het apparaat terugstellen

**JVC**

VICTOR COMPANY OF JAPAN, LIMITED



EN, GE, FR, NL

© 2003 VICTOR COMPANY OF JAPAN, LIMITED



0603MNMMDWJEIN

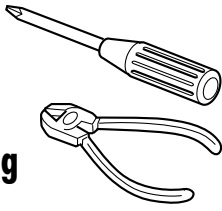

#### ENGLISH

- This unit is designed to operate on 12 V DC, NEGATIVE ground electrical systems.

## INSTALLATION (IN-DASH MOUNTING)

- The following illustration shows a typical installation. However, you should make adjustments corresponding to your specific car. If you have any questions or require information regarding installation kits, consult your JVC IN-CAR ENTERTAINMENT dealer or a company supplying kits.

- Before mounting:** Press (control panel release button) to detach the control panel if already attached.
  - When shipped from the factory, the control panel is packed in the hard case.
- Remove the trim plate.
- Remove the sleeve after disengaging the sleeve locks.
  - Stand the unit.
    - Note:** When you stand the unit, be careful not to damage the fuse on the rear.
  - Insert the 2 handles between the unit and the sleeve, as illustrated, to disengage the sleeve locks.
  - Remove the sleeve.
    - Note:** Be sure to keep the handles for future use after installing the unit.
- Install the sleeve into the dashboard.
  - After the sleeve is correctly installed into the dashboard, bend the appropriate tabs to hold the sleeve firmly in place, as illustrated.
- Fix the mounting bolt to the rear of the unit's body and place the rubber cushion over the end of the bolt.
- Do the required electrical connections.
- Slide the unit into the sleeve until it is locked.
- Attach the trim plate.
- Attach the control panel.

#### DEUTSCH

- Dieses Gerät ist für einen Betrieb in elektrischen Anlagen mit 12 V Gleichstrom und (-) Erdung ausgelegt.

## EINBAU (IM ARMATURENBRETT)

- Die folgende Abbildung zeigt einen typischen Einbau. Dennoch müssen Sie entsprechend Ihrem jeweiligen Auto Anpassungen vornehmen. Bei irgendwelchen Fragen oder wenn Sie Informationen hinsichtlich des Einbausatzes brauchen, wenden Sie sich an Ihren JVC Autoradiohändler oder ein Unternehmen das diese Einbausätze vertreibt.

- Vor dem Einbau:** Drücken Sie (Freigabe der Schalttafel), um die Arretierung der Schalttafel zu lösen, sofern diese bereits angebracht ist.
  - Bei der Auslieferung ab Werk ist die Schalttafel im Etui verpackt.
- Den Frontrahmen herausnehmen.
- Die Halterung nach dem Entriegeln der Halterungssperren abnehmen.
  - Das Gerät aufstellen.
    - Hinweis:** Beim Aufstellen des Geräts darauf achten, daß die Sicherung auf der Rückseite nicht beschädigt wird.
  - Die 2 Griffe zwischen dem Gerät und der Halterung wie abgebildet einstecken und die Halterungssperren entriegeln.
  - Die Halterung entfernen.
    - Hinweis:** Sicherstellen, daß die Griffe für künftigen Gebrauch nach dem Einbau des Geräts aufbewahrt werden.
- Die Halterung im Armaturenbrett einbauen.
  - Nach dem korrekten Einbau der Halterung im Armaturenbrett, die entsprechenden Riegel umknicken, um die Halterung an ihrem Platz zu sichern, siehe Abbildung.
- Die Befestigungsschraube an der Rückseite des Gerätekörpers befestigen und das Ende der Schraube mit einem Gummipuffer abdecken.
- Nehmen Sie die erforderlichen elektrischen Anschlüsse vor.
- Das Gerät in die Halterung schieben, bis es einrastet.
- Befestigen Sie den Frontrahmen.
- Die Schalttafel anbringen.

#### FRANÇAIS

- Cet appareil est conçu pour fonctionner sur des sources de courant continu de 12 V à masse NEGATIVE.

## INSTALLATION (MONTAGE DANS LE TABLEAU DE BORD)

- L'illustration suivante est un exemple d'installation typique. Cependant, vous devez faire les ajustements correspondant à votre voiture particulière. Si vous avez des questions ou avez besoin d'information sur des kits d'installation, consulter votre revendeur d'autoradios JVC ou une compagnie d'approvisionnement.

- Avant le montage:** Appuyer sur (déblocage du panneau de commande) pour éventuellement détacher le panneau de commande.
  - Lorsque ce panneau de commande sort d'usine, il est rangé dans un étui de transport.
- Retirer la plaque d'assemblage.
- Libérer les verrous du manchon et retirer le manchon.
  - Poser l'appareil à la verticale.
    - Remarque:** Lorsque vous mettez l'appareil à la verticale, faire attention de ne pas endommager le fusible situé sur l'arrière.
  - Insérer les 2 poignées entre l'appareil et le manchon comme indiqué pour désengager les verrous de manchon.
  - Retirer le manchon.
    - Remarque:** S'assurer de garder les poignées pour une utilisation ultérieure, après l'installation de l'appareil.
- Installer le manchon dans le tableau de bord.
  - Après installation correcte du manchon dans le tableau de bord, plier les bonnes pattes pour maintenir fermement le manchon en place, comme montré.
- Monter le boulon de montage sur l'arrière du corps de l'appareil puis passer l'amortisseur en caoutchouc sur l'extrémité du boulon.
- Réalisez les connexions électriques.
- Faire glisser l'appareil dans le manchon jusqu'à ce qu'il soit verrouillé.
- Attachez la plaque d'assemblage.
- Remonter le panneau de commande.

#### NEDERLANDS

- Dit apparaat mag worden gebruikt bij elektrische systemen die werken op 12 V gelijkstroom met negatieve aarding.

## INSTALLATIE (INBOUW IN HET DASHBOARD)

- Op de volgende afbeelding kunt u zien hoe de installatie, normaal gesproken, in zijn werk gaat. U moet echter bij de installatie rekening houden met de bijzonderheden van uw eigen auto. Neem bij vragen of voor meer bijzonderheden over inbouwpakketten contact op met uw JVC car audio dealer of een dealer of een bedrijf dat inbouwpakketten levert.

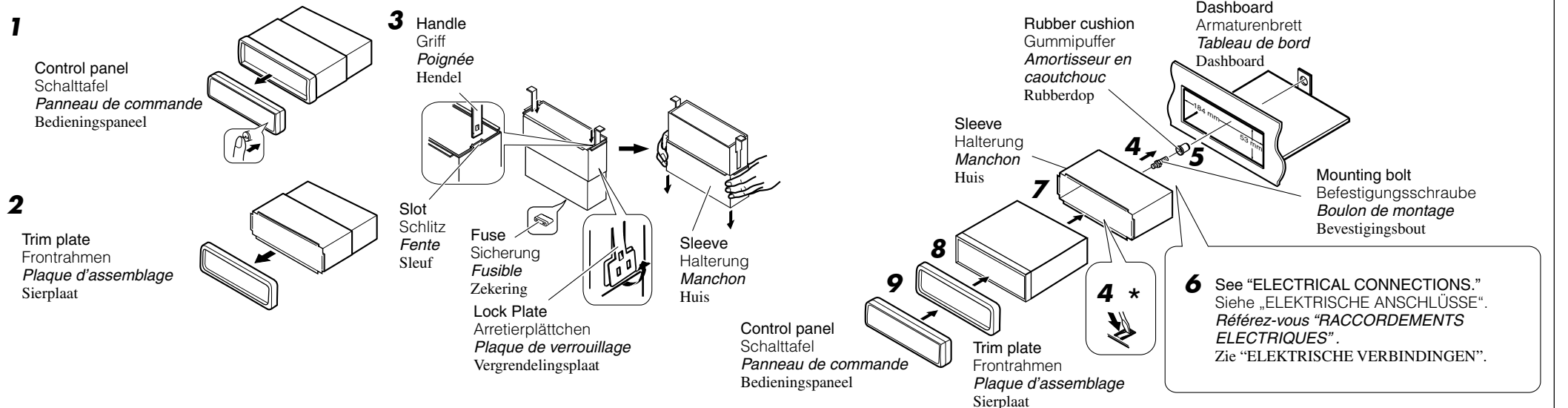

## TROUBLESHOOTING

- The fuse blows.**
  - Are the red and black leads connected correctly?
- Power cannot be turned on.**
  - Is the yellow lead connected?
- No sound from the speakers.**
  - Is the speaker output lead short-circuited?
- Sound is distorted.**
  - Is the speaker output lead grounded?
  - Are the "-" terminals of L and R speakers grounded in common?
- Unit becomes hot.**
  - Is the speaker output lead grounded?
  - Are the "-" terminals of L and R speakers grounded in common?

## FEHLERSUCHE

- Die Sicherung brennt durch.**
  - Sind die roten und schwarzen Leitungen richtig angeschlossen?
- Stromversorgung kann nicht eingeschaltet werden.**
  - Ist die gelbe Leitung angeschlossen?
- Kein Ton aus den Lautsprechern.**
  - Ist die LautsprecherAusgangsleitung kurzgeschlossen?
- Ton verzerrt.**
  - Ist die LautsprecherAusgangsleitung geerdet?
  - Sind die (-) Anschlußklemmen der linken und rechten Lautsprecher zusammen geerdet?
- Gerät wird heiß.**
  - Ist die LautsprecherAusgangsleitung geerdet?
  - Sind die (-) Anschlußklemmen der linken und rechten Lautsprecher zusammen geerdet?

## EN CAS DE DIFFICULTES

- Le fusible saute.**
  - Les fils rouge et noir sont-ils raccordés correctement?
- L'appareil ne peut pas être mise sous tension.**
  - Le fil jaune est-elle raccordée?
- Pas de son des enceintes.**
  - Le fil de sortie d'enceinte est-il court-circuité?
- Le son est déformé.**
  - Le fil de sortie d'enceinte est-il à la masse?
  - Les bornes "-" des enceintes gauche et droit sont-elles mises ensemble à la masse?
- L'appareil devient chaud.**
  - Le fil de sortie d'enceinte est-il à la masse?
  - Les bornes "-" des enceintes gauche et droit sont-elles mises ensemble à la masse?

## PROBLEMEN OPLOSSEN

- De zekering slaat door.**
  - Zijn de rode en de zwarte draden op de juiste manier aangesloten?
- De stroom kan niet worden ingeschakeld.**
  - Is de gele draad aangesloten?
- Er komt geen geluid uit de speakers.**
  - Is de uitgaande speakerdraad kortgesloten?
- Het geluid wordt vervormd.**
  - Is de uitgaande speakerdraad geaard?
  - Zijn de "-" polen van de linker- en de rechterspeakers gemeenschappelijk geaard?
- Het apparaat raakt verhit.**
  - Is de uitgaande speakerdraad geaard?
  - Zijn de "-" polen van de linker- en de rechterspeakers gemeenschappelijk geaard?

## Connecting to the steering wheel remote controller / Anschluß an die Lenkradfernbedienung / Connexion de la télécommande de volant / Verbinden met de stuurwiel-afstandsbediening

If your car is equipped with the steering wheel remote controller, you can operate this receiver using the controller. To do it, a JVC's OE remote adapter (not supplied) which matches with your car is required. Consult your JVC IN-CAR ENTERTAINMENT dealer for details. Wenn Ihr Fahrzeug mit einer Lenkradfernbedienung ausgestattet ist, können Sie damit diesen Receiver steuern. Hierfür ist ein für Ihr Fahrzeug passender Radio-Lenkrad-Fernbedienungsadaption von JVC (nicht im Lieferumfang enthalten) erforderlich. Für weitere Einzelheiten wenden Sie sich an Ihren JVC Autoradiohändler. Si votre voiture est munie d'une télécommande de volant, vous pouvez commander cet autoradio en utilisant la télécommande. Pour le faire, un adaptateur pour télécommande au volant (non fourni) correspondant à votre voiture est nécessaire. Consultez votre revendeur d'autoradio JVC pour les détails. Indien uw auto een stuurwiel-afstandsbediening heeft, kunt u deze receiver met die afstandsbediening bedienen. Hiervoor heeft u echter een JVC adapter voor stuurwiel-afstandsbediening (niet bijgeleverd) nodig die geschikt is voor uw auto. Raadpleeg uw JVC car audio dealer voor details.

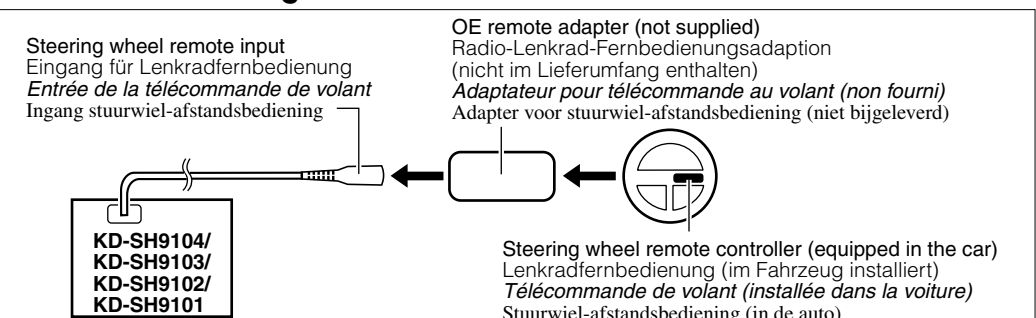



• **When using the optional stay / Beim Verwenden der Anker-Option / Lors de l'utilisation du hauban en option / Wanneer u de steun gebruikt (facultatief)**

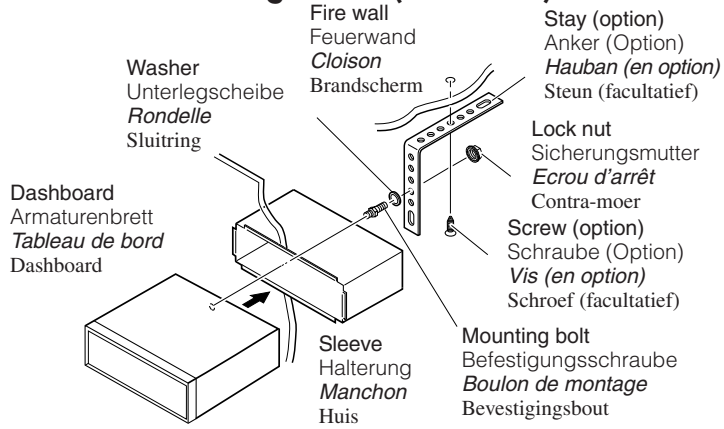

Less than 30°  
Weniger als 30°  
Moins de 30°  
Kleiner dan 30°

Install the unit at an angle of less than 30°.  
Stellen Sie das Gerät mit einem Winkel von weniger als 30° auf.  
Installez l'appareil avec un angle de moins de 30°.  
Installeer het toestel met een hoek kleiner dan 30°.

• **When installing the unit without using the sleeve / Beim Einbau des Geräts ohne Halterung / Lors de l'installation de l'appareil sans utiliser de manchon / Wanneer u het apparaat zonder huis installeert**

In a Toyota for example, first remove the car radio and install the unit in its place.  
Zum Beispiel in einem Toyota zuerst das Autoradio ausbauen und dann das Gerät an seinem Platz einbauen.  
Par exemple dans une Toyota, retirez d'abord l'autoradio et installez l'appareil à la place.  
Voorbeeld: Bij een Toyota moet u eerst de autoradio verwijderen en daarna het apparaat installeren.

Flat type screws (M5 x 6 mm)\*  
Senkkopfschrauben (M5 x 6 mm)\*  
Vis à tête plate (M5 x 6 mm)\*  
Platkop Schroeven (M5 x 6 mm)\*

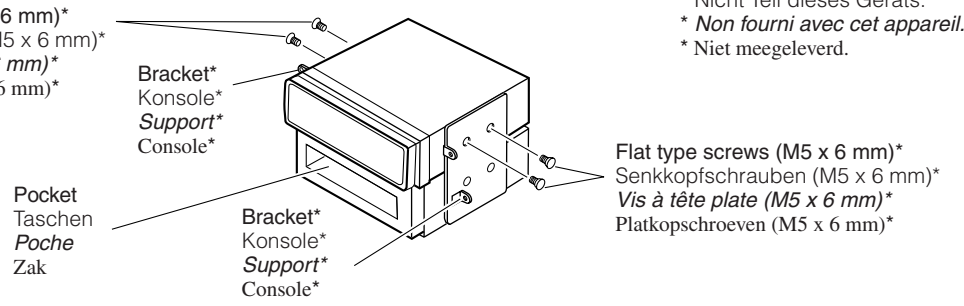

**Note** : When installing the unit on the mounting bracket, make sure to use the 6 mm-long screws. If longer screws are used, they could damage the unit.  
**Hinweis** : Beim Anbringen des Gerät an der Konsole sicherstellen, daß 6 mm lange Schrauben verwendet werden. Werden längere Schrauben verwendet, können sie das Gerät beschädigen.  
**Remarque** : Lors de l'installation de l'appareil sur le support de montage, s'assurer d'utiliser des vis d'une longueur de 6 mm. Si des vis plus longues sont utilisées, elles peuvent endommager l'appareil.  
**Opmerking** : Wanneer u het apparaat aan de bevestigingsklem vastmaakt, moet u de 6 mm lange schroeven gebruiken. Als u langere schroeven gebruikt, kan het apparaat worden beschadigd.

**Removing the unit**

- Before removing the unit, release the rear section.
- 1** Remove the control panel.
- 2** Remove the trim plate.
- 3** Insert the 2 handles into the slots, as shown. Then, while gently pulling the handles away from each other, slide out the unit. **(Be sure to keep the handles after installing it.)**

**Ausbau des Geräts**

- Vor dem Ausbau des Geräts den hinteren Teil freigeben.
- 1** Den Schalttafel abnehmen.
- 2** Den Frontrahmen herausnehmen.
- 3** Die 2 Griffe in die Schlitze wie gezeigt stecken. Dann die Griffe behutsam auseinander ziehen und das Gerät herausziehen. **(Die Griffe nach dem Einbau auf jeden Fall aufbewahren.)**

**Retrait de l'appareil**

- Avant de retirer l'appareil, libérer la section arrière.
- 1** Retirer le panneau de commande.
- 2** Retirer la plaque d'assemblage.
- 3** Introduire les 2 poignées dans les fentes, comme montré. Puis, tout en tirant doucement les poignées écartées, faire glisser l'appareil pour le sortir. **(S'assurer de conserver les poignées après l'installation de l'appareil.)**

**Verwijderen van het apparaat**

- Voordat u het apparaat verwijderd, moet u het achtergedeelte losmaken.
- 1** Verwijder het bedieningspaneel.
- 2** Verwijder de sierplaat.
- 3** Plaats de 2 hendels, zoals afgebeeld, in de sleuven. Daarna duwt u de hendels zachtjes uit elkaar en kunt u het apparaat naar buiten schuiven. **(Bewaar de hendels nadat u het apparaat hebt geïnstalleerd!)**

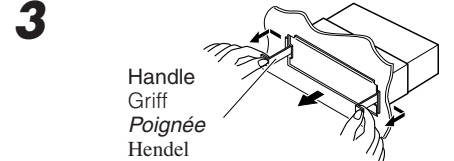

**Parts list for installation and connection**

The following parts are provided with this unit. After checking them, please set them correctly.

Hard case/Control panel  
Etui/Schalttafel  
Etui de transport/Panneau de commande  
Behuizing/Bedieningspaneel

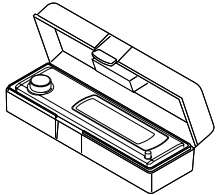

Washer (ø5)  
Unterlegscheibe (ø5)  
Rondelle (ø5)  
Sluistring (ø5)



Lock nut (M5)  
Sicherungsmutter (M5)  
Ecrou d'arrêt (M5)  
Contra-moer (M5)



**Teileliste für den Einbau und Anschluß**

Die folgenden Teile werden zusammen mit diesem Gerät geliefert. Nach ihrer Überprüfung, die Teile richtig einsetzen.

Sleeve  
Halterung  
Manchon  
Huis

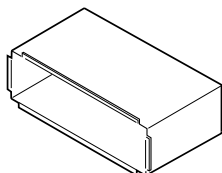

Mounting bolt (M5 x 20 mm)  
Befestigungsschraube (M5 x 20 mm)  
Boulon de montage (M5 x 20 mm)  
Bevestigingsbout (M5 x 20 mm)



Trim plate  
Frontrahmen  
Plaque d'assemblage  
Sierplaat

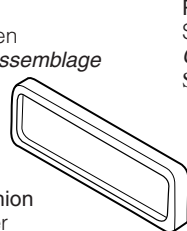

Rubber cushion  
Gummipuffer  
Amortisseur en caoutchouc  
Rubberdop



**Liste des pièces pour l'installation et raccordement**

Les pièces suivantes sont fournies avec cet appareil. Après vérification, veuillez les placer correctement.

Power cord  
Stromkabel  
Cordon d'alimentation  
Stroomkabel

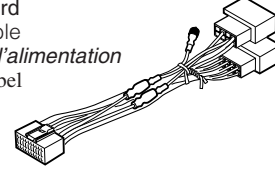

Handles  
Griffe  
Poignées  
Hendels

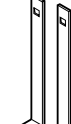

**Lijst van onderdelen die u bij installatie en aansluiting nodig hebt**

De volgende onderdelen worden bij het apparaat geleverd. Installeer ze op de juiste wijze, nadat u ze hebt gecontroleerd.

Remote controller  
Fernbedienung  
Télécommande  
Afstandsbediening

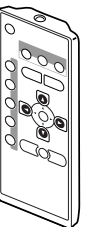

Battery  
Batterie  
Pile  
Batterij



CD-ROM (Image Converter)  
CD-ROM (Image Converter)  
CD-ROM (Image Converter)  
CD-ROM (Image Converter)



**ELECTRICAL CONNECTIONS**

To prevent short circuits, we recommend that you disconnect the battery's negative terminal and make all electrical connections before installing the unit. If you are not sure how to install this unit correctly, have it installed by a qualified technician.

**Note:**

This unit is designed to operate on 12 V DC, **NEGATIVE ground electrical systems.** If your vehicle does not have this system, a voltage inverter is required, which can be purchased at JVC IN-CAR ENTERTAINMENT dealers.

- Replace the fuse with one of the specified rating. If the fuse blows frequently, consult your JVC IN-CAR ENTERTAINMENT dealer.
- If noise is a problem... This unit incorporates a noise filter in the power circuit. However, with some vehicles, clicking or other unwanted noise may occur. If this happens, connect the unit's rear ground terminal (see connection diagram) to the car's chassis using shorter and thicker cords, such as copper braiding or gauge wire. If noise still persists, consult your JVC IN-CAR ENTERTAINMENT dealer.
- Maximum input of the speakers should be more than 50 W at the rear and 50 W at the front, with an impedance of 4 Ω to 8 Ω.
- **Be sure to ground this unit to the car's chassis.**
- The heat sink becomes very hot after use. Be careful not to touch it when removing this unit.

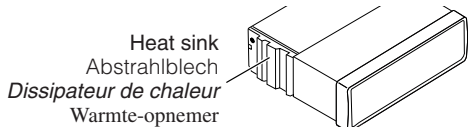

**ELEKTRISCHE ANSCHLÜSSE**

Zur Vermeidung von Kurzschlüssen empfehlen wir, daß Sie den negativen Batterieanschluß abtrennen und alle elektrischen Anschlüsse herstellen, bevor das Gerät eingebaut wird. Sind Sie sich über den richtigen Einbau des Geräts nicht sicher, lassen Sie es von einem qualifizierten Techniker einbauen.

**Hinweis:**

Dieses Gerät ist für einen Betrieb in **elektrischen Anlagen mit 12 V Gleichstrom und (-) Erdung ausgelegt.** Verfügt Ihr Fahrzeug nicht über diese Anlage, ist ein Spannungsinverter erforderlich, der bei JVC Autoradiohändler erworben werden kann.

- Die Sicherung mit einer der entsprechenden Nennleistung ersetzen. Brennt die Sicherung häufig durch, wenden Sie sich an ihren JVC Autoradiohändler.
- Sind Störgeräusche ein Problem... Dieses Gerät enthält ein Störfilter im Stromkreis. Bei manchen Fahrzeugen kann jedoch ein Klicken oder andere unerwünschte Störgeräusche auftreten. Sollte das der Fall sein, die **hintere Erdungscanschlussschleife** (siehe Schaltplan) des Geräts am Fahrwerk des Fahrzeugs anschließen, dabei kürzere und dickere Kabel wie beispielsweise Kupfergeflecht draht oder Stahldraht verwenden. Bleibt Störgeräusch bestehen, wenden Sie sich an Ihren JVC Autoradiohändler.
- Die maximale Eingangsleistung der Lautsprecher sollte mehr als 50 W hinten und 50 W vorn bei einer Impedanz von 4 Ω bis 8 Ω betragen.
- **Sicherstellen, daß das Gerät am Fahrwerk geerdert wird.**
- Das Abstrahlblech wird nach dem Gebrauch sehr heiß. Beim Ausbau des Geräts darauf achten, das Abstrahlblech nicht zu berühren.

**RACCORDEMENTS ELECTRIQUES**

Pour éviter tout court-circuit, nous vous recommandons de débrancher la borne négative de la batterie et d'effectuer tous les raccordements électriques avant d'installer l'appareil. Si l'on n'est pas sûr de pouvoir installer correctement cet appareil, le faire installer par un technicien qualifié.

**Remarque:**

Cet appareil est conçu pour fonctionner sur des sources de courant continu de 12 V à masse **NEGATIVE.** Si votre véhicule n'offre pas ce type d'alimentation, il vous faut un convertisseur de tension, que vous pouvez acheter chez un revendeur d'autoradios JVC.

- Remplacer le fusible par un de la valeur précisée. Si le fusible saute souvent, consulter votre revendeur d'autoradios JVC.
- Si le bruit est un problème... Cet appareil incorpore un filtre de bruit dans le circuit d'alimentation. Cependant, avec certains véhicules, quelques claquements ou autres bruits non désirés risquent de se produire. Si cela arrive, raccorder la borne arrière de masse de l'appareil au châssis de la voiture (voir le diagramme de raccordement) en utilisant des cordons les plus gros et les plus courts possibles telle qu'une barre de cuivre ou une tresse. Si le bruit persiste, consulter votre revendeur d'autoradios JVC.
- La puissance admissible des enceintes devrait supérieure à 50 W à l'arrière et à 50 W l'avant, avec une impédance de 4 Ω à 8 Ω.
- S'assurer de raccorder la mise à la masse de cet appareil au châssis de la voiture.
- Le dissipateur de chaleur devient très chaud après usage. Faire attention de ne pas le toucher en retirant cet appareil.

**ELEKTRISCHE VERBINDINGEN**

Om kortsluiting te voorkomen adviseren wij u om de minpool van de accu los te maken en alle elektrische verbindingen tot stand te brengen voordat u het apparaat in de auto installeert. Als u niet zeker weet hoe u dit apparaat moet installeren, kunt u dit beter door een daartoe gekwalificeerde technicus laten doen.

**Opmerking:**

Dit apparaat mag worden gebruikt bij elektrische systemen die werken op 12 V gelijkstroom met **negatieve aarding.** Als uw auto niet is uitgerust met een dergelijk systeem, is een spanningsomzetter vereist. Dit instrument kan worden aangeschaft bij JVC car audio dealers.

- Vervang de zekering door een exemplaar met het aangegeven vermogen. Als de zekering vaak doorslaat, moet u uw JVC car audio dealer raadplegen.
- Als u geluidsproblemen hebt... De krachtschakeling van dit apparaat heeft een ingebouwd geluidsfilter. In sommige voertuigen zijn tikgeluiden of andere ongewenste geluiden te horen. Als dit gebeurt, moet u de **massaklem aan de achterkant** (zie aansluitingsschema) aan het chassis van de auto vastmaken met behulp van een kortere en dikkere kabel, zoals kopermanteldraad of tellerkabel. Als het geluid niet verdwijnt, moet u contact opnemen met uw JVC car audio dealer.
- Het maximum ingangsvermogen van de speakers moet achterin meer dan 50 W zijn en voorin 50 W, met een impedantie van 4 Ω tot 8 Ω.
- **Zorg ervoor dat dit apparaat door middel van een aardkabel is verbonden met het chassis van de auto.**
- De warmte-opnemer kan na gebruik erg heet worden. Raak de warmte-opnemer niet aan wanneer u dit apparaat van zijn plaats haalt.

**Connecting the leads / Anschließen der Leitungen / Raccordement des fils / Aansluiting van de gekleurde draden**

Twist the core wires when connecting. Die Kerndrähte beim Anschließen verdrehen. **Torsader les âmes des fils en les raccordant.** Draai de kerndraden om elkaar heen wanneer u ze wilt aansluiten.

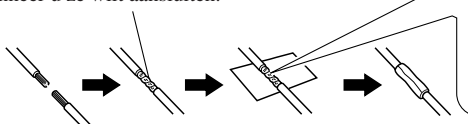

Solder the core wires to connect them securely. Die Kerndrähte anlöten, um sie fest anzuschließen. **Souder les âmes des fils pour les raccorder entre eux de façon sûre.** Soldeer de kerndraden zodat ze stevig vast zitten.



**CAUTION / VORSICHT / PRECAUTION / LET OP!:**

- To prevent short-circuit, cover the terminals of the UNUSED leads with insulating tape.
- Zur Vermeidung eines Kurzschlusses die Anschlußklemmen der NICHT VERWENDETEN Leitungen mit Isolierklebeband umwickeln.
- **Pour éviter les court-circuits, couvrir les bornes des fils qui ne sont PAS UTILISÉS avec de la bande isolante.**
- Om kortsluiting te voorkomen, moet u de aansluitklemmen van ONGEBRUIKTE gekleurde draden met isolatieband bedekken.

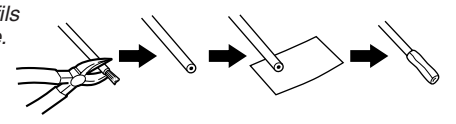



**A If your car is equipped with the ISO connector  
Wenn Ihr Auto mit ISO-Steckern ausgestattet ist  
Si votre voiture est équipée d'un connecteur ISO  
Indien uw auto is uitgerust met de ISO-connector**

- Connect the ISO connectors as illustrated.
- Die ISO-Stecker wie abgebildet anschließen.
- *Connectez les connecteurs ISO comme montré sur l'illustration.*
- Sluit de ISO-connectoren aan zoals op het voorbeeld is aangegeven.

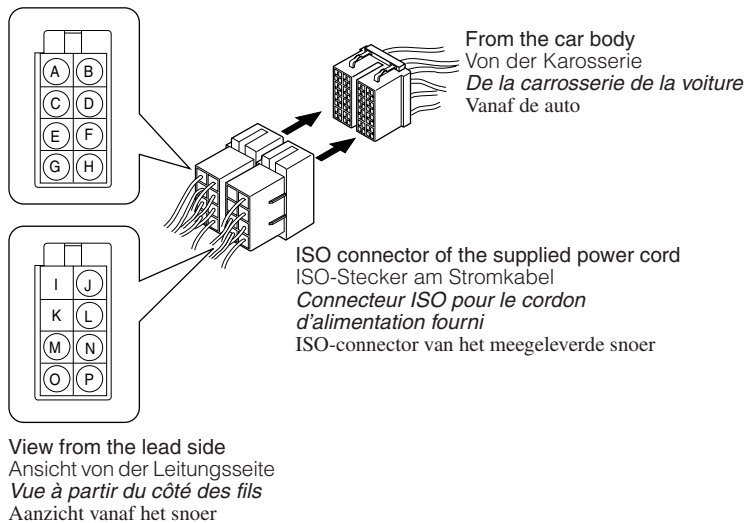

**For some VW/Audi or Opel (Vauxhall) automobile  
Für manche VW/Audi oder Opel (Vauxhall) Fahrzeuge  
Pour certaine voiture VW/Audi ou Opel (Vauxhall)  
Voor bepaalde modellen VW/Audi of Opel (Vauxhall) geldt**

You may need to modify the wiring of the supplied power cord as illustrated.

- Contact your authorized car dealer before installing this unit.
- Sie müssen evtl. die Verdrahtung des mitgelieferten Stromkabels wie abgebildet ändern.
- Wenden Sie sich an Ihre Vertragswerkstatt, bevor Sie das Gerät einbauen.
- *Vous aurez peut-être besoin de modifier le câblage du cordon d'alimentation fourni comme montré sur l'illustration.*
- *Contactez votre revendeur automobile autorisé avant d'installer l'appareil.*

Wellicht moet u de bedrading van het meegeleverde snoer als in het voorbeeld aanpassen.

- Neem contact op met uw officiële autodealer alvorens dit apparaat te installeren.

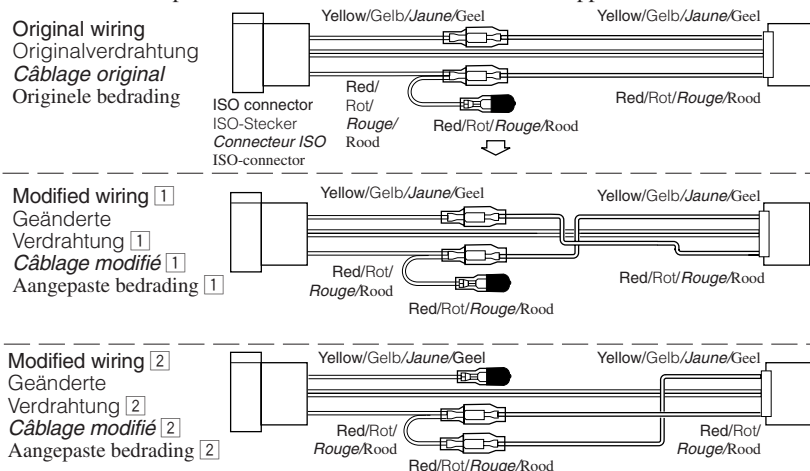

Use modified wiring [2] if the unit does not turn on. Geänderte Verdrahtung [2] verwenden, wenn das Gerät so nicht an geht. *Utilisez le câblage modifié [2] si l'appareil ne se met pas sous tension.* Pas de bedrading [2] aan indien het apparaat niet reageert bij inschakelen.

**B Connections without using the ISO connectors / Anschlüsse ohne ISO-Stecker / Connexions sans l'utilisation des connecteurs ISO / Verbindingen zonder ISO-connectoren**

**Before connecting:** Check the wiring in the vehicle carefully. Incorrect connection may cause serious damage to this unit. The leads of the power cord and those of the connector from the car body may be different in colour.

- 1 Cut the ISO connector.
- 2 Connect the colored leads of the power cord to the car battery, speakers and power aerial (if any) in the following sequence:
  - 1 Black: ground
  - 2 Yellow: to car battery (constant 12 V)
  - 3 Red: to an accessory terminal
  - 4 Blue with white stripe: to the remote lead of other equipment or power aerial if any (200 mA max.)
  - 5 Orange with white stripe: to car light control switch
  - 6 Brown: to cellular phone system (for details, refer to the instructions of the cellular phone.)
  - 7 Others: to speakers
- 3 Connect the aerial cord.
- 4 Finally connect the wiring harness to the unit.

**Vor dem Anschließen:** Die Verdrahtung im Fahrzeug sorgfältig überprüfen. Falsche Anschlüsse können ernsthafte Schäden am Gerät hervorrufen. Die Leiter des Stromkabels und die Leiter des Anschlusses im Fahrzeug können sich farblich unterscheiden.

- 1 Den ISO-Stecker abschneiden.
- 2 Die farbigen Leitungen des Spannungsversorgungskabels an der Autobatterie, den Lautsprechern und dem Motorantenne (sofern vorhanden) in folgender Reihenfolge anschließen.
  - 1 Schwarz: Erdung
  - 2 Gelb: an Autobatterie (konstant 12 V)
  - 3 Rot: zur einer Zubehöransteckleuchte
  - 4 Blau mit weißem Streifen: zum Zusatzkabel des anderen Geräts oder der Motorantenne, sofern vorhanden (max. 200 mA)
  - 5 Orange mit weißem Streifen: zur Autolichtschalter
  - 6 Braun: zur Mobiltelefon (weitere Informationen entnehmen Sie bitte der Bedienungsanleitung des Mobiltelefons.)
  - 7 Andere: zur Lautsprecher
- 3 Das Antennenkabel anschließen.
- 4 Die Kabelbäume am Gerät anschließen.

**Avant de commencer la connexion:** Vérifiez attentivement le câblage du véhicule. Une connexion incorrecte peut endommager sérieusement l'appareil. Le fil du cordon d'alimentation et ceux des connecteurs du châssis de la voiture peuvent être différents en couleur.

- 1 Coupez le connecteur ISO.
- 2 Connectez les fils de couleur du cordon d'alimentation à la batterie de la voiture, aux enceintes et à l'antenne automatique (s'il y en a une) dans l'ordre suivant.
  - 1 Noir: à la masse
  - 2 Jaune: à la batterie de la voiture (12 V constant)
  - 3 Rouge: à une borne accessoire
  - 4 Bleu avec bande blanche: au fil de télécommande de l'autre appareil ou à l'antenne automatique s'il y en a une (200 mA max.)
  - 5 Orange avec bande blanche: à l'interrupteur d'éclairage de la voiture
  - 6 Marron: à un système de téléphone cellulaire (pour les détails, se référer aux instructions du téléphone cellulaire.)
  - 7 Autres: aux enceintes
- 3 Connectez le cordon d'antenne.
- 4 Finalement, connectez le faisceau de fils à l'appareil.

**Alvorens de verbindingen tot stand te brengen:** Moet u de bedrading in de auto zorgvuldig. Het apparaat kan door verkeerde verbindingen ernstige schade oplopen. De draden van het stroomkabel verschillen mogelijk van kleur met de aansluitingen op het chassis van de auto.

- 1 Knip de ISO-connector los.
- 2 Sluit de gekleurde snoerdraden van de stroomkabel in de hierna genoemde volgorde aan op de accu van de auto, de luidsprekers en de antenne (indien aanwezig).
  - 1 Zwart: aarde
  - 2 Geel: naar de accu van de auto (constant 12 V)
  - 3 Rood: naar de aansluitklem van de accessoire
  - 4 Blauw met witte streep: naar afstandsdraad van andere apparatuur of antenne met circuit indien aanwezig (200 mA max.)
  - 5 Oranje met witte streep: naar de schakelaar voor de autoverlichting
  - 6 Bruin: naar het mobiele-telefoonsysteem (lees voor meer informatie de instructies die bij de mobiele telefoon worden geleverd.)
  - 7 Andere: naar de speakers
- 3 Sluit de antenne aan.
- 4 Verbind de draadbundel daarna met het apparaat.

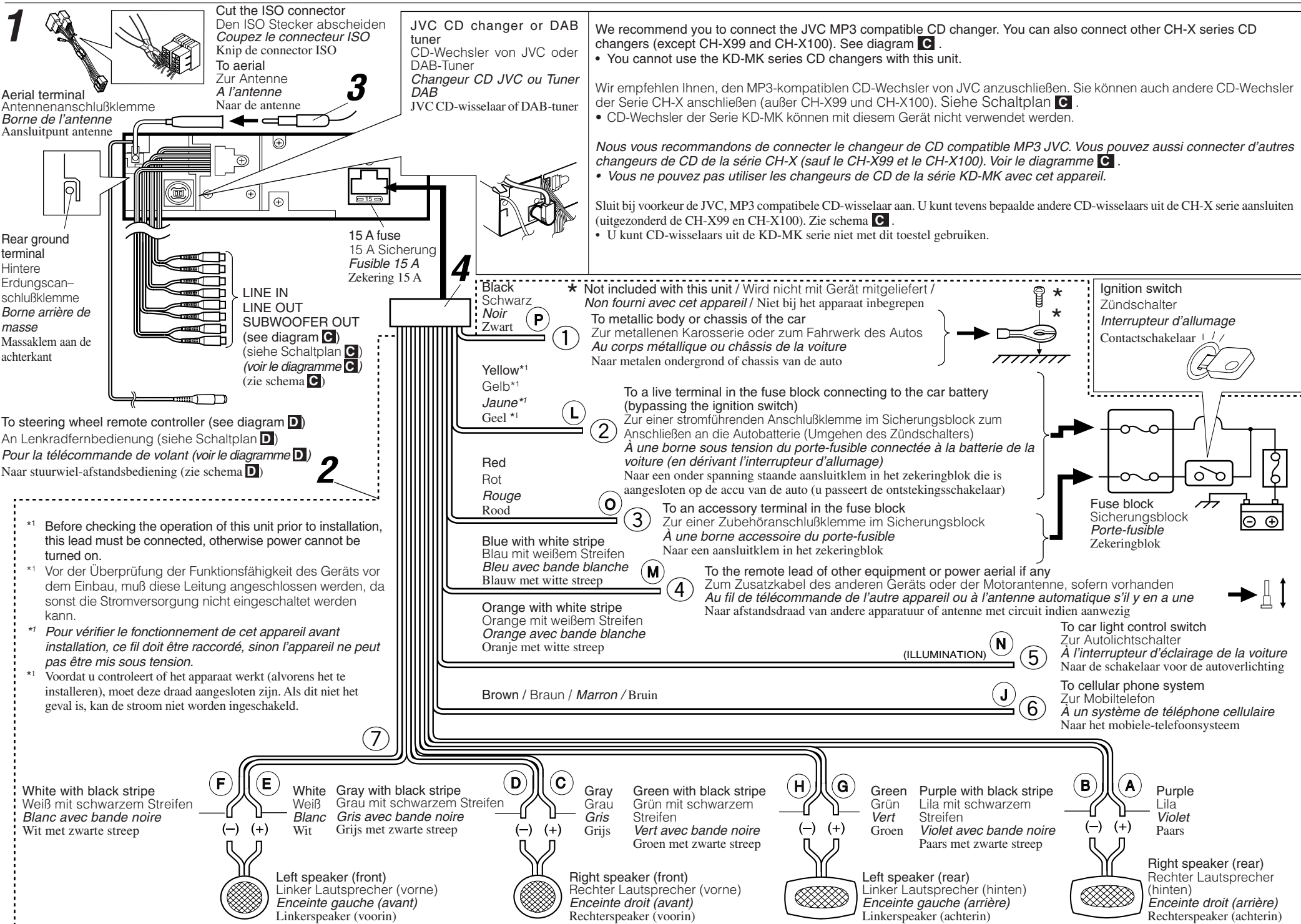

- \*1 Before checking the operation of this unit prior to installation, this lead must be connected, otherwise power cannot be turned on.
- \*1 Vor der Überprüfung der Funktionsfähigkeit des Geräts vor dem Einbau, muß diese Leitung angeschlossen werden, da sonst die Stromversorgung nicht eingeschaltet werden kann.
- \*1 *Pour vérifier le fonctionnement de cet appareil avant installation, ce fil doit être raccordé, sinon l'appareil ne peut pas être mis sous tension.*
- \*1 Voordat u controleert of het apparaat werkt (alvorens het te installeren), moet deze draad aangesloten zijn. Als dit niet het geval is, kan de stroom niet worden ingeschakeld.

## PRECAUTIONS on power supply and speaker connections:

- DO NOT connect the speaker leads of the power cord to the car battery; otherwise, the unit will be seriously damaged.
- Connect the black lead (ground), yellow lead (to car battery, constant 12 V), and red lead (to an accessory terminal) correctly.
- BEFORE connecting the speaker leads of the power cord to the speakers, check the speaker wiring in your car.
- If the speaker wiring in your car is as illustrated in Fig. 1 and Fig. 2 below, DO NOT connect the unit using that original speaker wiring. If you do, the unit will be seriously damaged.
- Redo the speaker wiring so that you can connect the unit to the speakers as illustrated in Fig. 3.
- If the speaker wiring in your car is as illustrated in Fig. 3, you can connect the unit using the original speaker wiring in your car.
- If you are not sure of the speaker wiring of your car, consult your car dealer.

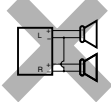

Fig. 1

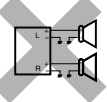

Fig. 2

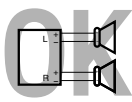

Fig. 3

## VORSICHTSMASSREGELN beim Anschließen der Stromversorgung und Lautsprecher:

- Die Lautsprecherleitungen des Netzkabels NICHT an der Autobatterie anschließen, da sonst das Gerät schwer beschädigt wird.
- Die schwarze Leitung (Erdung), die gelbe Leitung (zur Autobatterie, konstant 12 V) und die rote Leitung (zur Zubehörschlüsselklemme) richtig anschließen.
- VOR dem Anschließen der Lautsprecherleitungen des Spannungsversorgungskabels an die Lautsprecher, die Lautsprecherverdrahtung in Ihrem Auto überprüfen.
- Ist die Lautsprecherverdrahtung wie unten in "Fig. 1" und "Fig. 2" abgebildet, das Gerät NICHT mit der Originalverdrahtung der Lautsprecher anschließen, da sonst das Gerät schwer beschädigt wird.
- Die Lautsprecherverdrahtung erneuern, so daß Sie das Gerät an den Lautsprechern wie in "Fig. 3" abgebildet anschließen können.
- Ist die Lautsprecherverdrahtung in Ihrem Auto wie in "Fig. 3" abgebildet, können Sie das Gerät mit der Originalverdrahtung der Lautsprecher in Ihrem Auto anschließen.
- Sind Sie sich über die Lautsprecherverdrahtung in Ihrem Auto nicht sicher, wenden Sie sich an Ihren Autohändler.

## PRECAUTIONS sur l'alimentation et la connexion des enceintes:

- NE CONNECTEZ PAS les fils d'enceintes du cordon d'alimentation à la batterie; sinon, l'appareil serait sérieusement endommagé.
- Connectez correctement le fil noir (à la masse), le fil jaune (à la batterie de la voiture, 12 V constant) et le fil rouge (à la prise accessoire).
- AVANT de connecter les fils d'enceintes du cordon d'alimentation aux enceintes, vérifiez le câblage des enceintes de votre voiture.
- Si le câblage des enceintes de votre voiture est comme montré sur la Fig. 1 ou Fig. 2 ci-dessous, NE CONNECTEZ PAS l'appareil en utilisant ce câblage original des enceintes. Si vous le faites, l'appareil sera sérieusement endommagé.
- Recommencez le câblage des enceintes de façon que vous puissiez connecter l'appareil aux enceintes comme montré sur la Fig. 3.
- Si le câblage des enceintes de votre voiture est comme montré sur la Fig. 3, vous pouvez connecter l'appareil en utilisant ce câblage original d'enceintes pour votre voiture.
- Si vous n'êtes pas sûrs du câblage d'enceintes de votre voiture, consulter le concessionnaire de votre voiture.

## VOORZORGSMAATREGELEN bij het verbinden van de stroomkabel met de speakers:

- Verbind de speakerdraden van de stroomkabel NIET met de accu van de auto; als u dit wel doet, zal het apparaat ernstige schade oplopen.
- Sluit de zwarte draad (aarde), de gele draad (naar de accu van de auto, constant 12 V) en de rode draad (naar de aansluitklem van de accessoire) op de juiste wijze aan.
- VOORDAT u de speakerdraden van de stroomkabel met de speakers verbindt, moet u de bedrading van de speakers in uw auto controleren.
- Als de bedrading van de speakers eruit ziet zoals hieronder staat afgebeeld in Fig. 1 en Fig. 2, mag het apparaat NIET worden aangesloten met behulp van deze oorspronkelijke speakerbedrading. Als u dat wel doet, zal het apparaat ernstige schade oplopen.
- Pas de bedrading van de speakers aan, zodat u het apparaat met de speakers kunt verbinden, zoals staat afgebeeld in Fig. 3.
- Als de bedrading van de speakers eruit ziet zoals staat afgebeeld in Fig. 3, kunt u het apparaat aansluiten met behulp van de oorspronkelijke speakerbedrading in uw auto.
- Als u twijfels hebt over de speakerbedrading in uw auto, moet u contact opnemen met uw autodealer.

## Connections Adding Other Equipment / Anschlüsse zum Hinzufügen von anderer Ausrüstung / Raccordement pour ajouter d'autres appareils / Aansluitingen voor het toevoegen van andere apparatuur

### Amplifier / Verstärker / Amplificateur / Versterker

You can connect an amplifier and other equipment to upgrade your car stereo system.

- Connect the remote lead (blue with white stripe) to the remote lead of the other equipment so that it can be controlled through this unit.
- For amplifier only:
  - Disconnect the speakers from this unit, connect them to the amplifier. Leave the speaker leads of this unit unused.
  - You can switch off the built-in amplifier and send the audio signals only to the external amplifier(s) to get clear sounds and to prevent internal heat built-up inside the unit. See page 49 of the Instructions (separate volume).
  - The line output level of this unit is kept high to maintain the hi-fi sounds reproduced from this unit.

Sie können einen Verstärker oder ein anderes Gerät anschließen, um Ihre Autostereoanlage zu erweitern.

- Schließen Sie das Fernbedienungskabel (blau mit weißem Streifen) an das Fernbedienungskabel des anderen Geräts an, so daß es über dieses Gerät gesteuert werden kann.
- Nur für den Verstärker:
  - Die Lautsprecher von diesem Gerät abtrennen und am Verstärker anschließen. Die Lautsprecherleitungen dieses Geräts unbenutzt lassen.
  - Sie können den eingebauten Verstärker ausschalten und die Audio-Signale nur an die externe Komponente senden, um ein klares Klangbild zu erhalten und um eine interne Wärmeentwicklung innerhalb des Geräts zu verhindern. Siehe Seite 49 der Anweisungen (separates Dokument).
  - Der Ausgangspegel dieses Geräts wird auf einem hohen Wert gehalten, um den HiFi-Klang zu unterstützen, den dieses Gerät reproduziert.

Vous pouvez connecter un amplificateur ou autre appareil pour améliorer votre système autoradio.

- Connectez le fil de commande à distance (bleu avec bande blanche) au fil de commande à distance de l'autre appareil de façon qu'il puisse être commandé via cet appareil.
- Pour l'amplificateur seulement:
  - Déconnectez les enceintes de cet appareil et connectez-les à l'amplificateur. Laissez les fils d'enceintes de cet appareil inutilisés.
  - Vous pouvez désactiver l'amplificateur intégré et envoyer les signaux audio uniquement à un ou plusieurs amplificateurs extérieurs afin d'obtenir un son clair et pour éviter un surchauffement interne de l'appareil. Référez-vous à la page 49 du mode d'emploi (volume séparé).
  - Le niveau de sortie de ligne de cet appareil est maintenu à un niveau élevé pour maintenir une qualité Hi-Fi pour les sons reproduits par cet appareil.

Het is mogelijk om uw autostereosysteem uit te breiden met een versterker of andere apparatuur.

- Verbind de externe kabel (blauw met witte streep) met de externe kabel van het andere apparaat zodat deze op afstand vanaf deze apparaat kan worden bediend.
- Alleen voor een versterker:
  - Koppel de speakers van dit apparaat los en verbind ze aan de versterker.
  - U kunt de ingebouwde versterker uitschakelen zodat de audiosignalen uitsluitend via de externe versterker(s) worden gestuurd voor een helder geluid en het voorkomen van oververhitting van het toestel. Zie bladzijde 49 van de Gebruiksaanwijzing (apart boekje).
  - Het uitgangsniveau van het geluid is hoog om het hifi-geluid van deze eenheid te behouden.

Signal cord (not supplied with this unit)  
Einzelleitung (nicht mit diesem Gerät mitgeliefert)  
Cordon de signal (non fourni avec cet appareil)  
Signaalkabel (wordt niet bij dit apparaat geleverd)

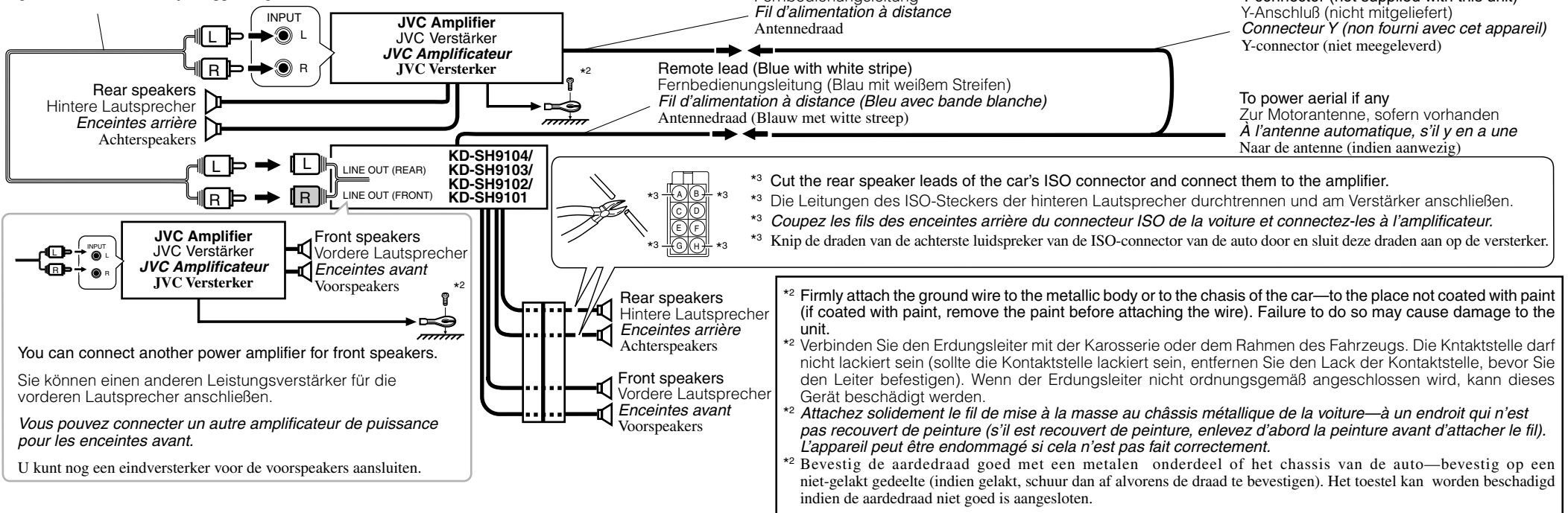

\*3 Cut the rear speaker leads of the car's ISO connector and connect them to the amplifier.  
\*3 Die Leitungen des ISO-Steckers der hinteren Lautsprecher durchtrennen und am Verstärker anschließen.  
\*3 Coupez les fils des enceintes arrière du connecteur ISO de la voiture et connectez-les à l'amplificateur.  
\*3 Knip de draden van de achterste luidspreker van de ISO-connector van de auto door en sluit deze draden aan op de versterker.

\*2 Firmly attach the ground wire to the metallic body or to the chassis of the car—to the place not coated with paint (if coated with paint, remove the paint before attaching the wire). Failure to do so may cause damage to the unit.  
\*2 Verbinden Sie den Erdungsleiter mit der Karosserie oder dem Rahmen des Fahrzeugs. Die Kontaktstelle darf nicht lackiert sein (sollte die Kontaktstelle lackiert sein, entfernen Sie den Lack der Kontaktstelle, bevor Sie den Leiter befestigen). Wenn der Erdungsleiter nicht ordnungsgemäß angeschlossen wird, kann dieses Gerät beschädigt werden.  
\*2 Attachez solidement le fil de mise à la masse au châssis métallique de la voiture—à un endroit qui n'est pas recouvert de peinture (s'il est recouvert de peinture, enlevez d'abord la peinture avant d'attacher le fil). L'appareil peut être endommagé si cela n'est pas fait correctement.  
\*2 Bevestig de aardedraad goed met een metalen onderdeel of het chassis van de auto—bevestig op een niet-gelakt gedeelte (indien gelakt, schuur dan af alvorens de draad te bevestigen). Het toestel kan worden beschadigd indien de aardedraad niet goed is aangesloten.

## CD changer and DAB tuner / CD-Wechsler und DAB-Tuner / Changeur CD et tuner DAB / CD-wisselaar en DAB-tuner

Connecting cord supplied with your DAB tuner  
Verbindingskabel, das zum Lieferumfang des DAB-Tuners gehört  
Cordon de connexion fourni avec votre tuner DAB  
Verbindingskabel die met de DAB-tuner wordt meegeleverd

Connecting cord supplied with your CD changer  
Verbindingskabel, das zum Lieferumfang des CD-Wechsler gehört  
Cordon de connexion fourni avec votre changeur CD  
Verbindingskabel die met de CD-wisselaar wordt meegeleverd

Connecting cord supplied with your DAB tuner or CD changer  
Verbindingskabel, das zum Lieferumfang des DAB-Tuners oder CD-Wechslers gehört  
Cordon de connexion fourni avec votre tuner DAB ou changeur CD  
Verbindingskabel die met de DAB-tuner of CD-wisselaar wordt meegeleverd

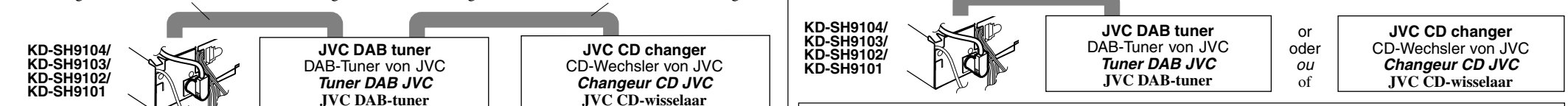

- You can connect both components in series as illustrated above.
- Es ist möglich, beide Komponenten in einer Serienschaltung entsprechend der obigen Darstellung anzuschließen.
- Vous pouvez connecter les deux appareils en série comme montré ci-dessus.
- Beide apparaten zijn volgens bovenstaande illustratie in serie aan te sluiten.

- Before connecting the CD changer and/or the DAB tuner, make sure that the unit is turned off.
- Bevor Sie den CD-Wechsler und/oder den DAB-Tuner anschließen, vergewissern Sie sich, daß das Gerät ausgeschaltet ist.
- Avant de connecter le changeur CD et/ou le tuner DAB, s'assurer que l'unité est éteinte.
- Zorg ervoor dat de apparaat is uitgeschakeld alvorens u de en/of DAB-tuner CD-wisselaar aansluit.

## External Component / Externe Komponente / Appareil extérieur / Extern apparaat

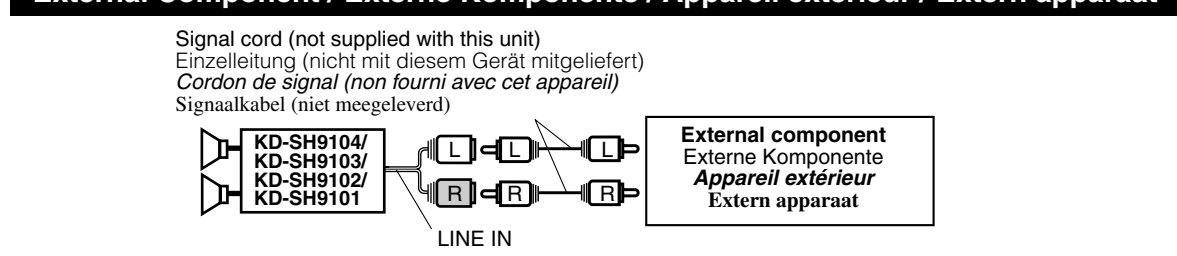

## Subwoofer / Subwoofer / Caisson de grave / Subwoofer

